

31

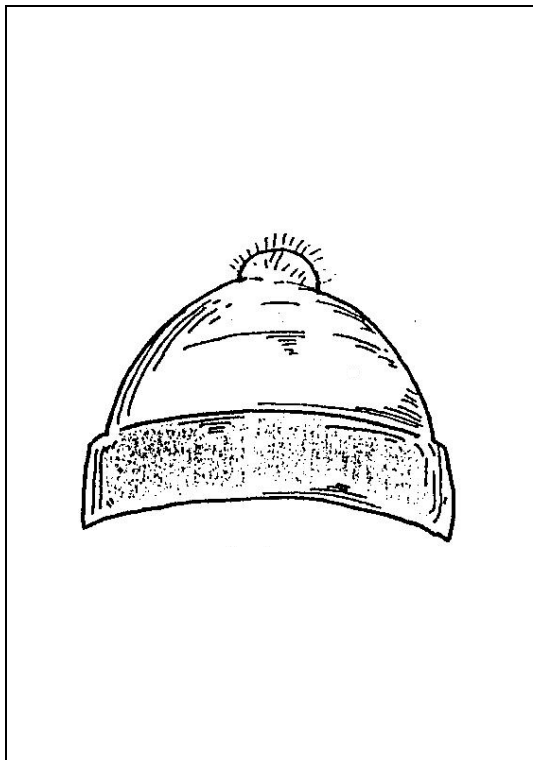

57

[Escribir texto]

Osorio- Nanjarí- Fonoaudiología

[Escribir texto]

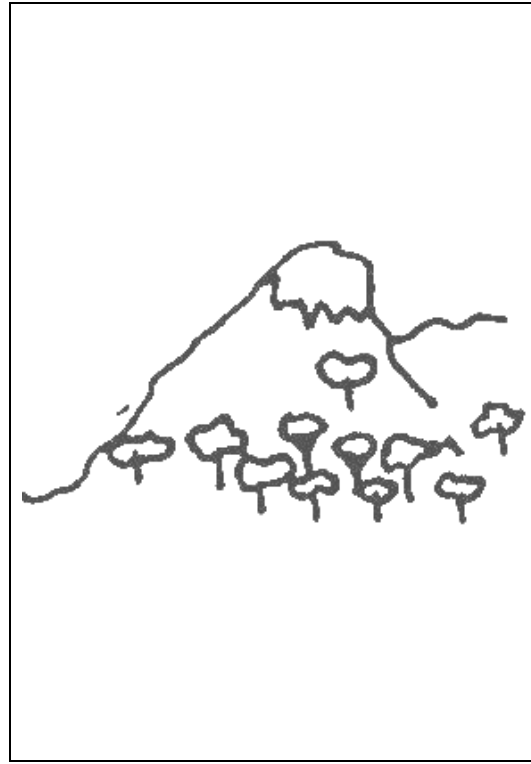
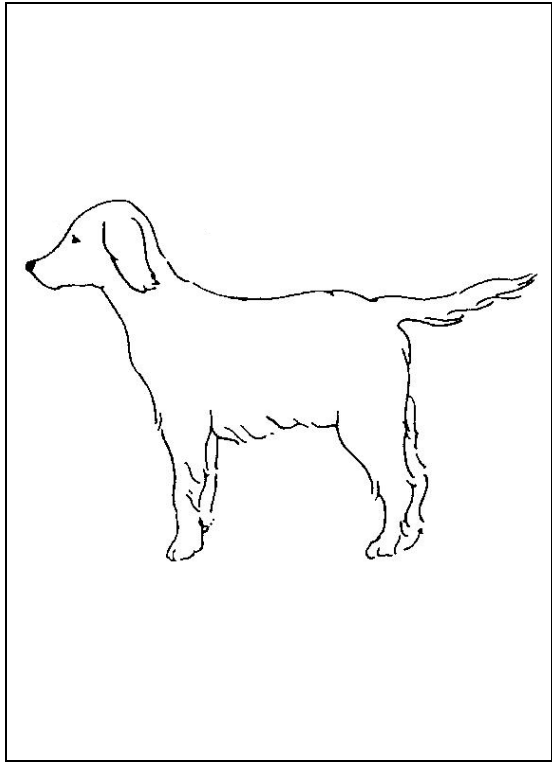

20

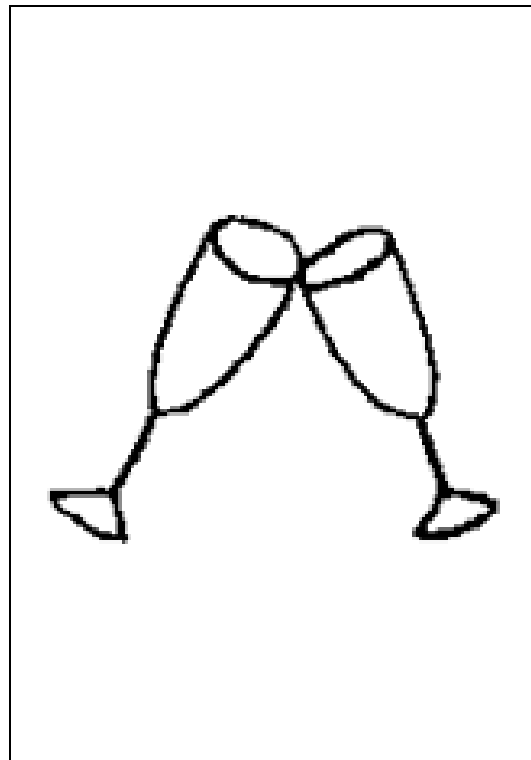
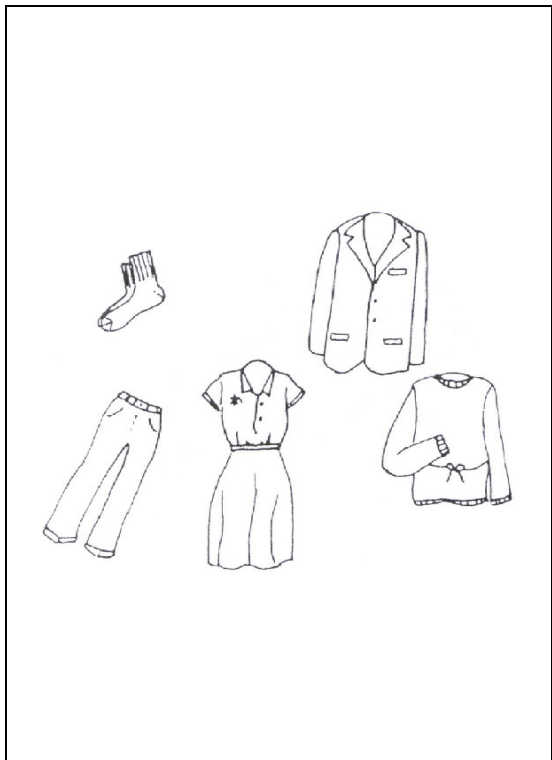

56

[Escribir texto]

Osorio- Nanjarí- Fonoaudiología

[Escribir texto]

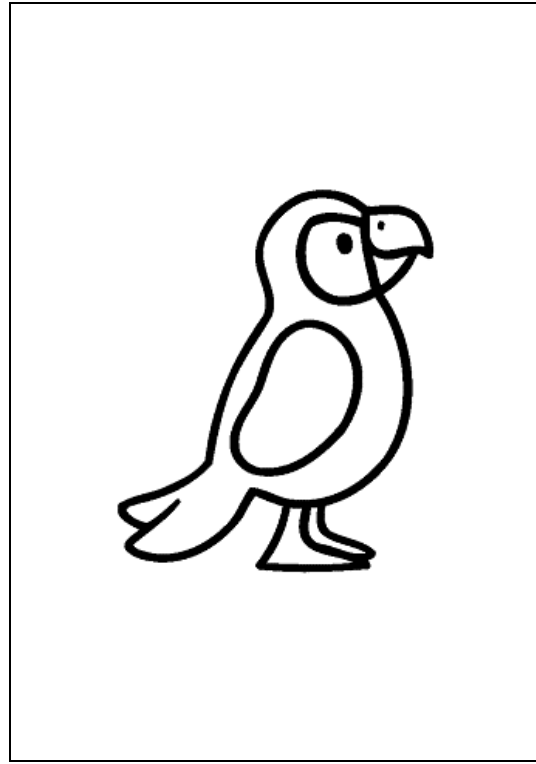
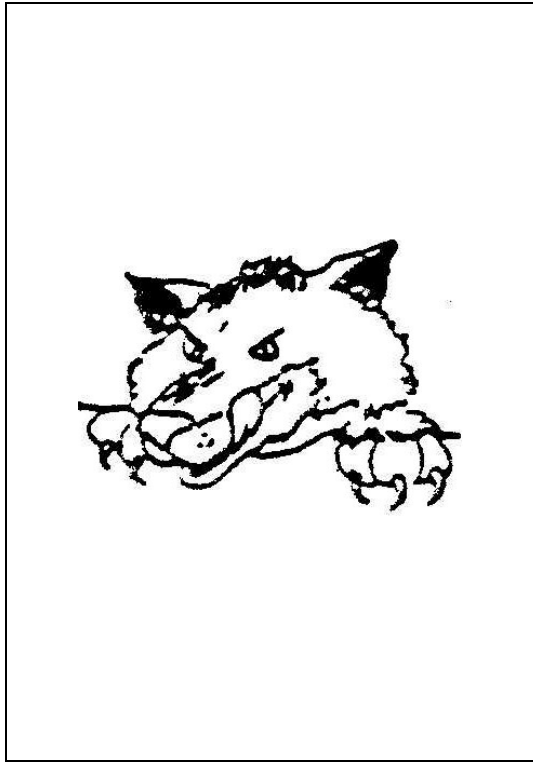

43

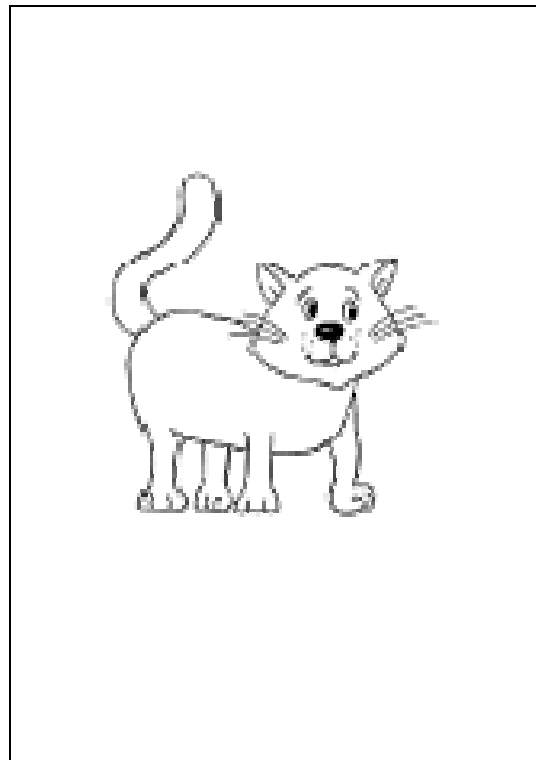
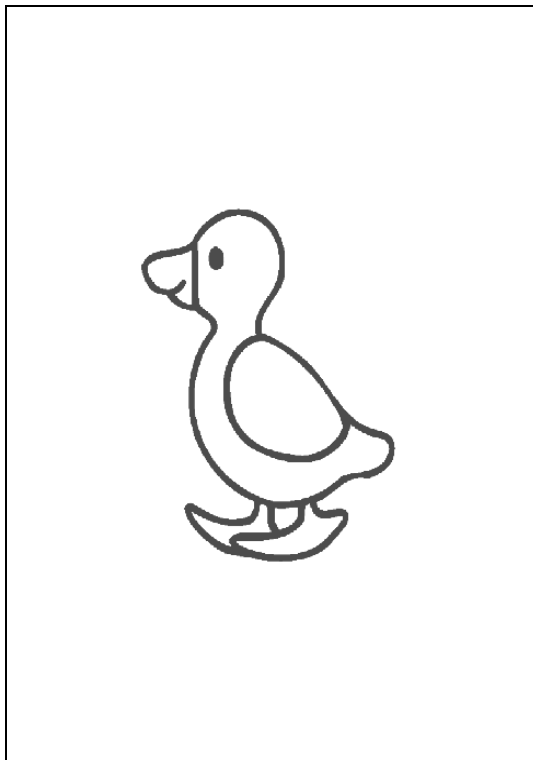

19

[Escribir texto]

Osorio- Nanjarí- Fonoaudiología

[Escribir texto]

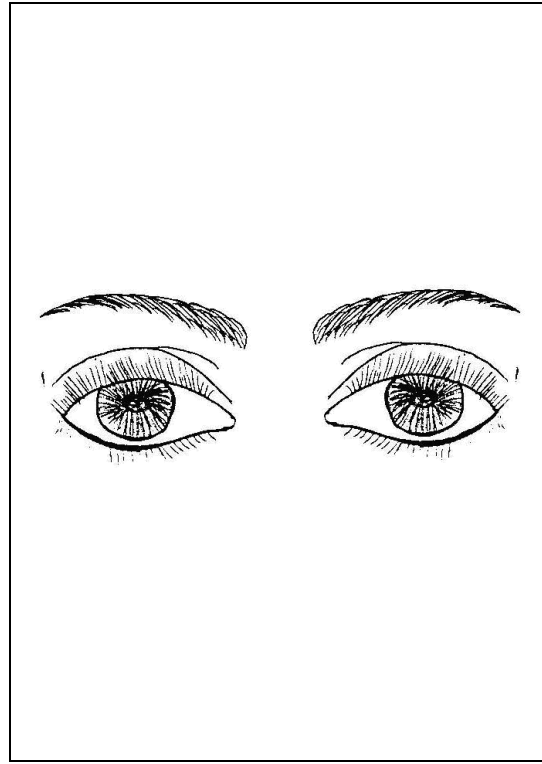
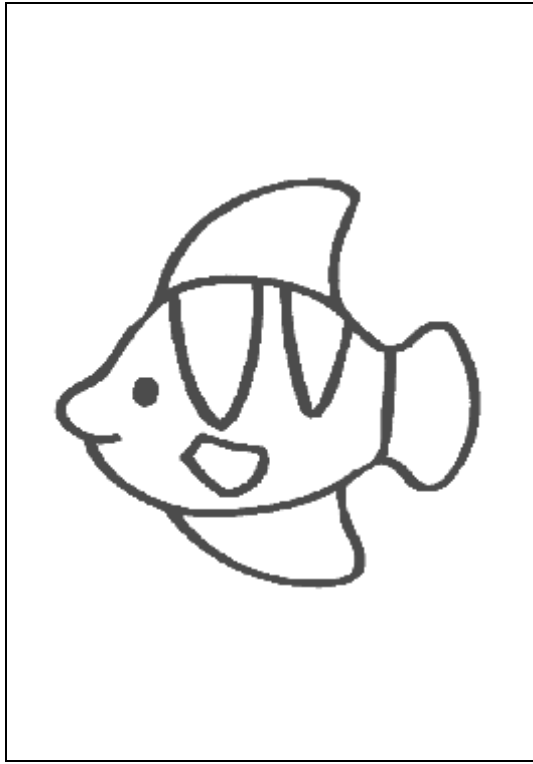

3

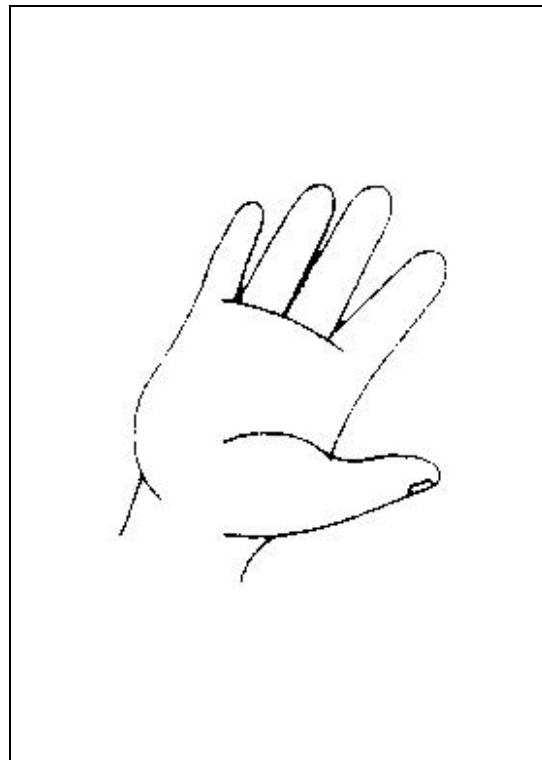
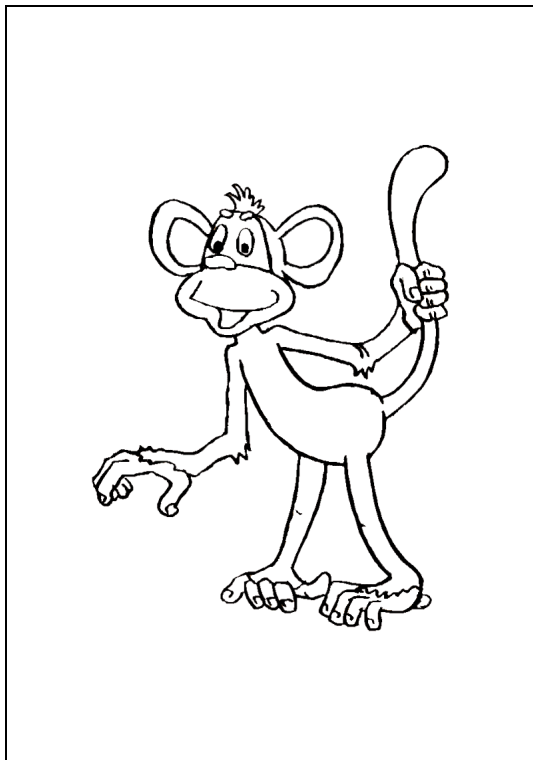

61

[Escribir texto]

Osorio- Nanjarí- Fonoaudiología

[Escribir texto]

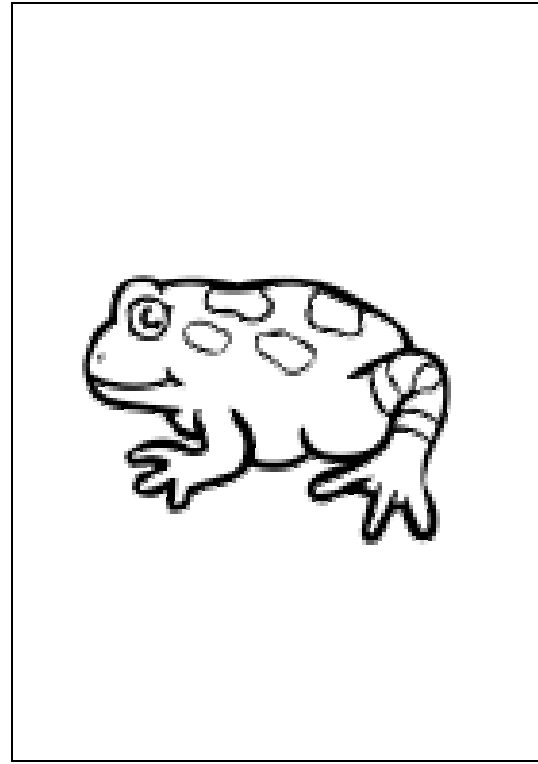
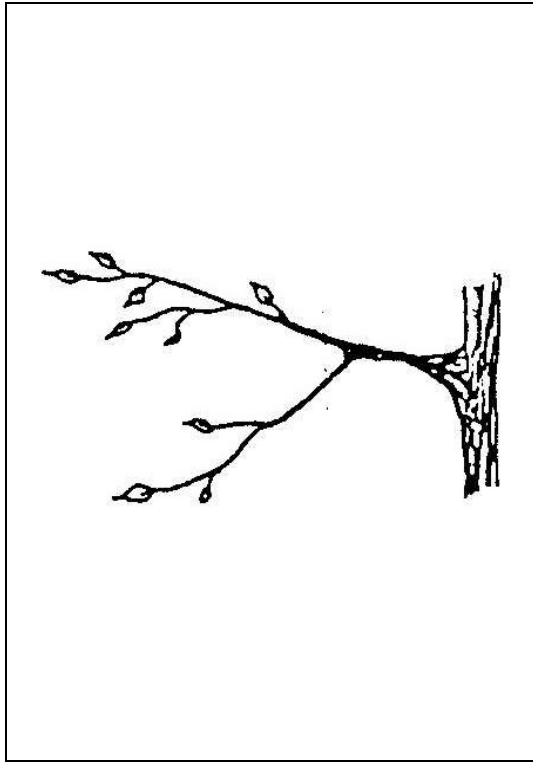

21

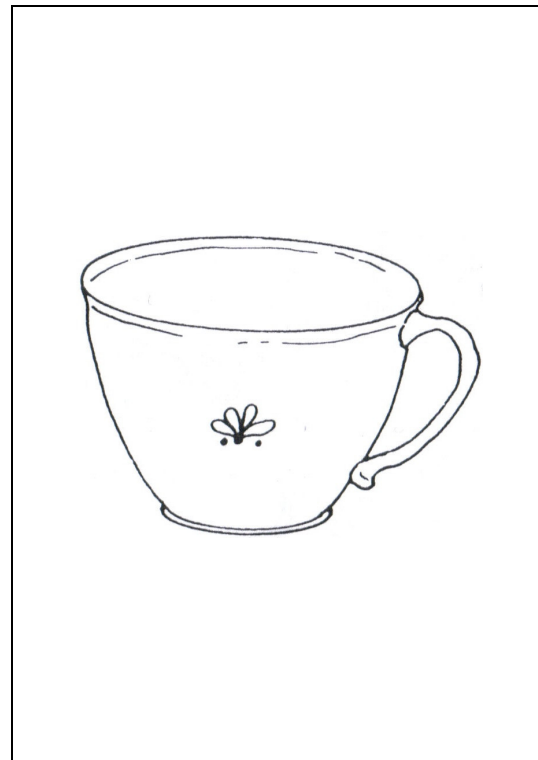
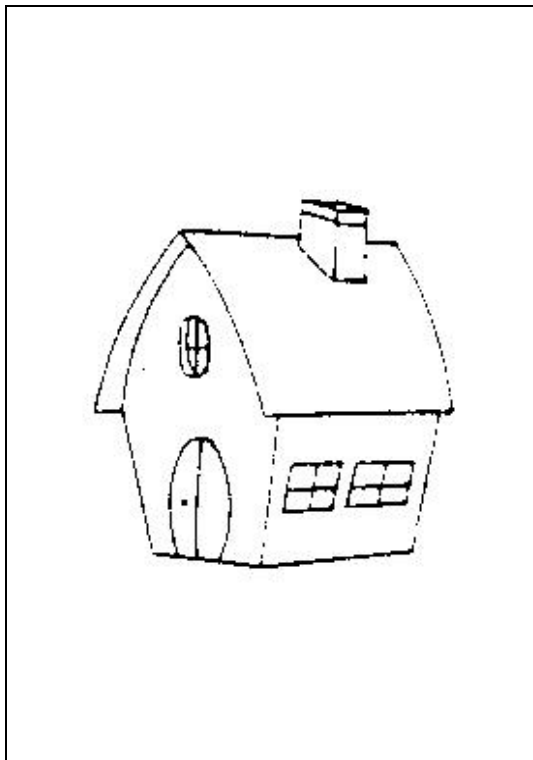

29

[Escribir texto]

Osorio- Nanjarí- Fonoaudiología

[Escribir texto]

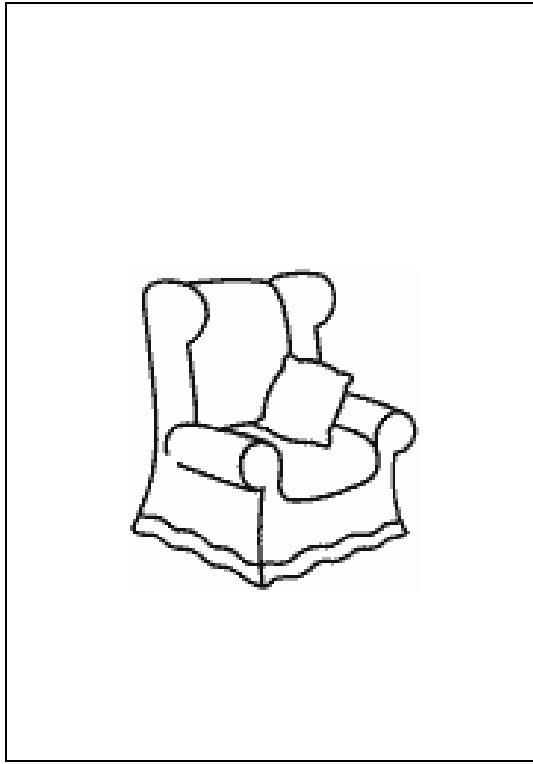

23

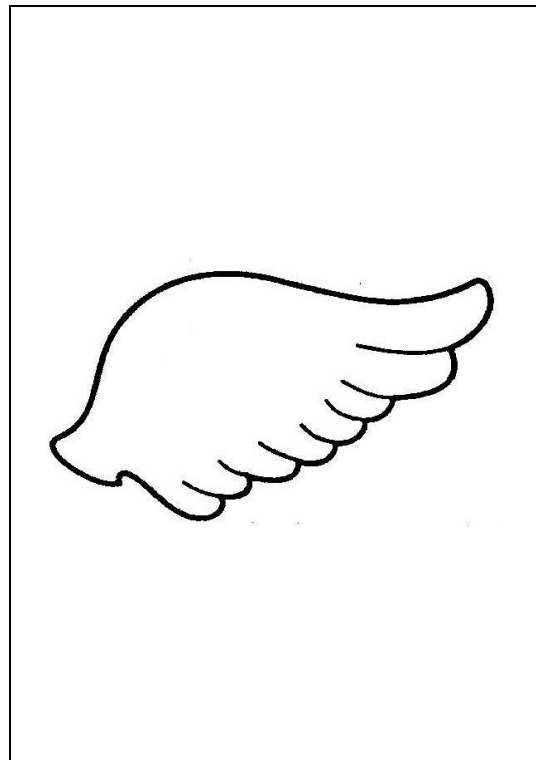

27

[Escribir texto]

Osorio- Nanjarí- Fonoaudiología

[Escribir texto]

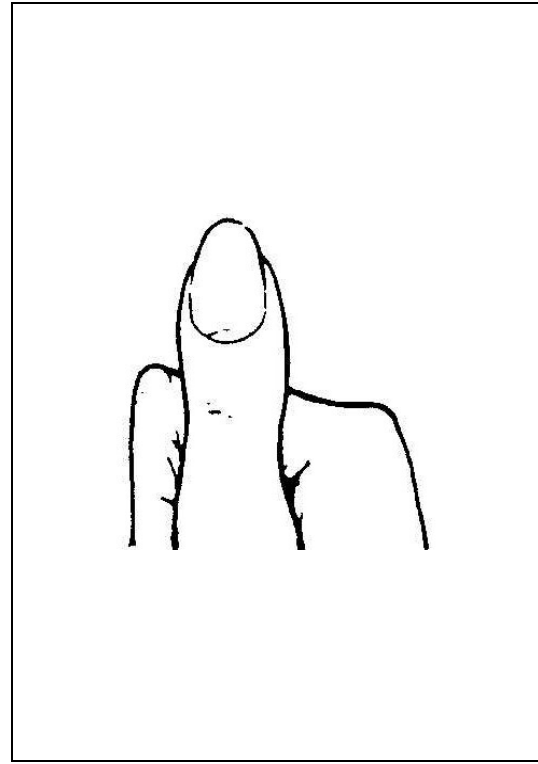
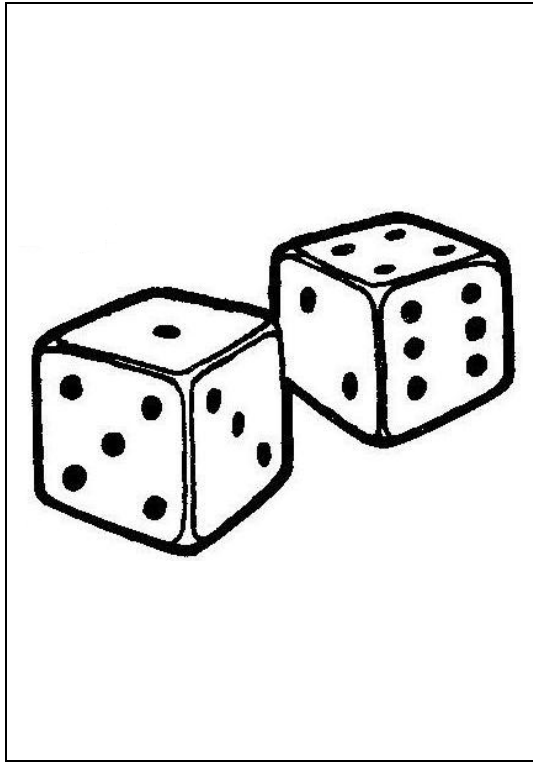

65

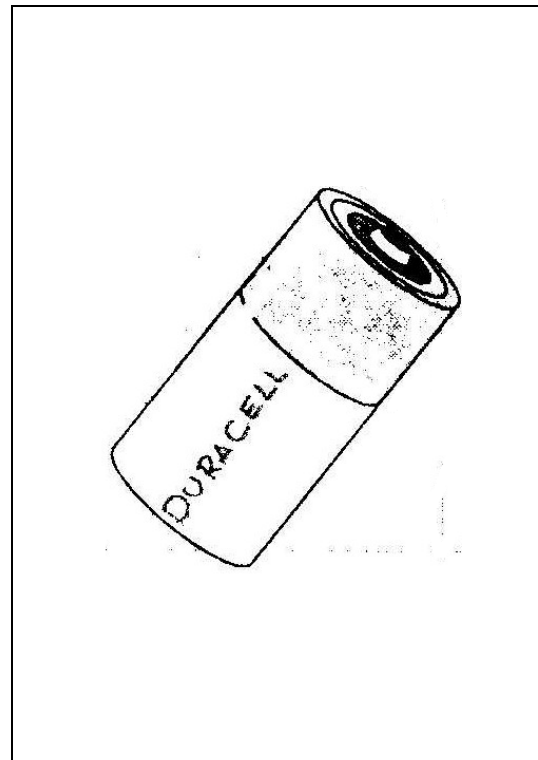
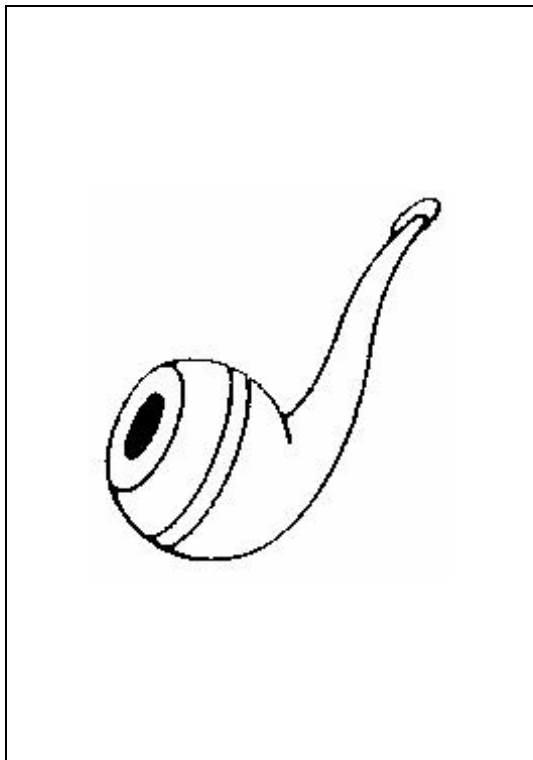

15

[Escribir texto]

Osorio- Nanjarí- Fonoaudiología

[Escribir texto]

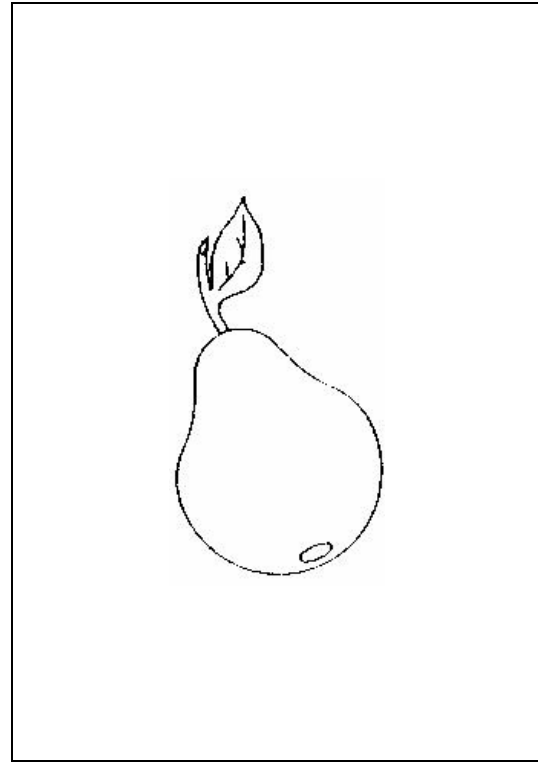

49

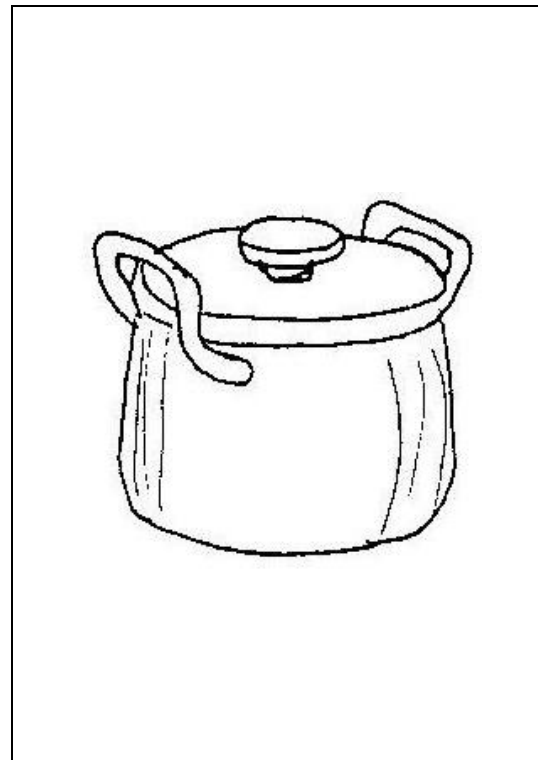
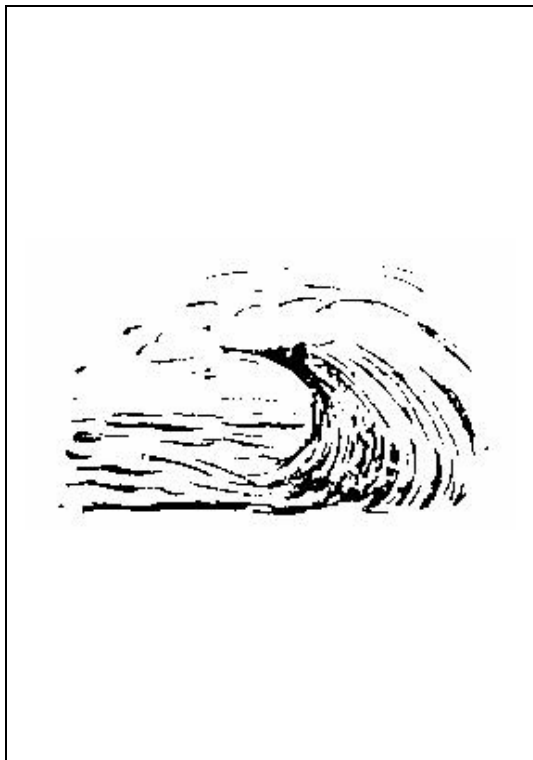

39

[Escribir texto]

Osorio- Nanjarí- Fonoaudiología

[Escribir texto]



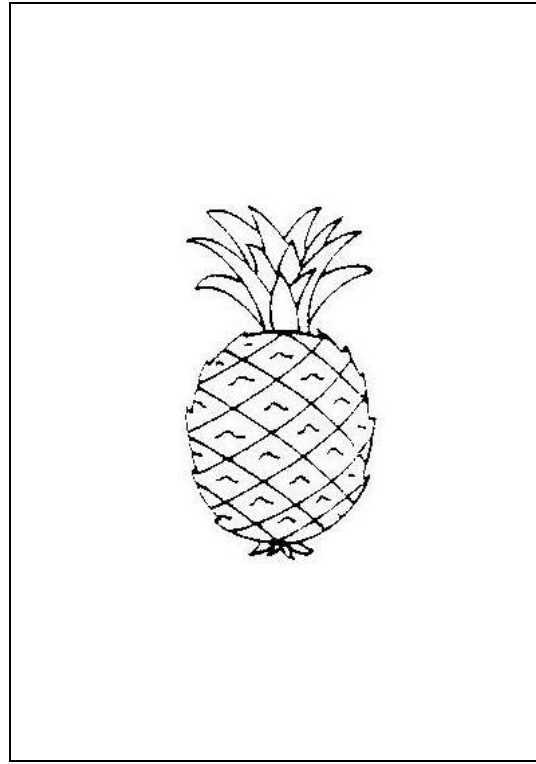
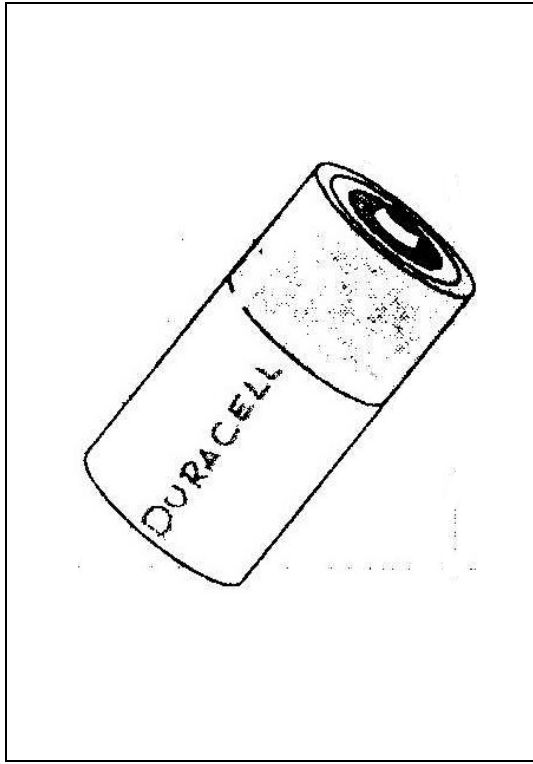

41

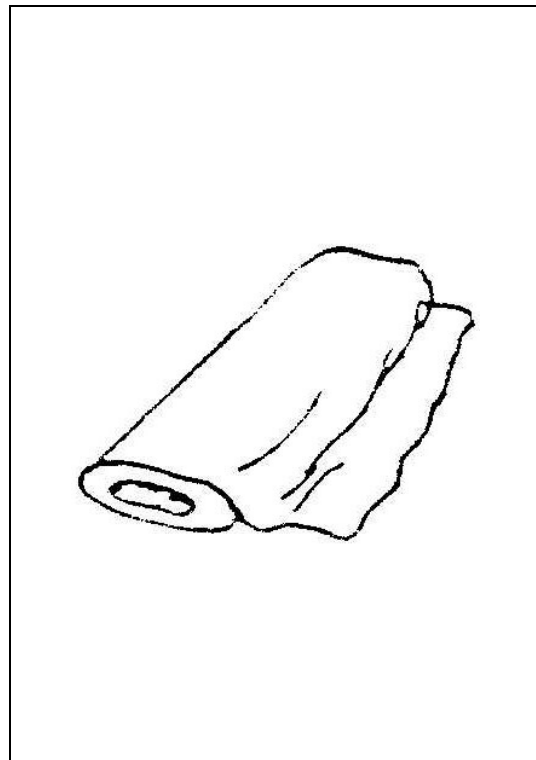
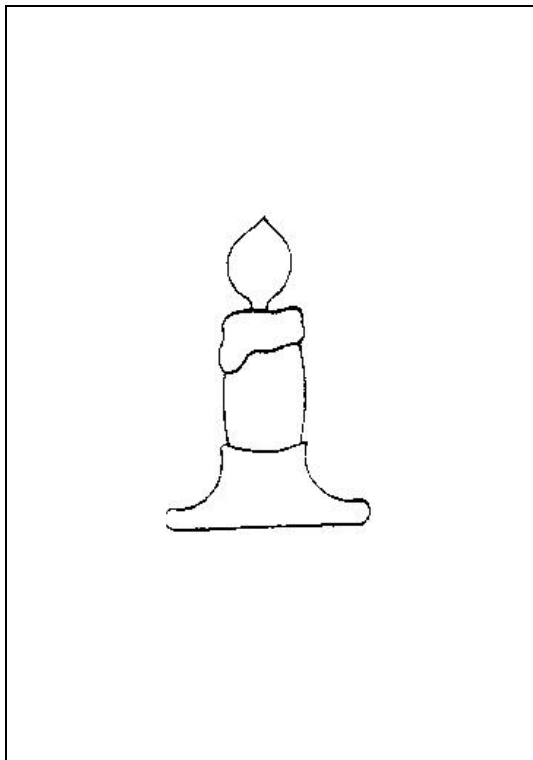

7

[Escribir texto]

Osorio- Nanjarí- Fonoaudiología

[Escribir texto]

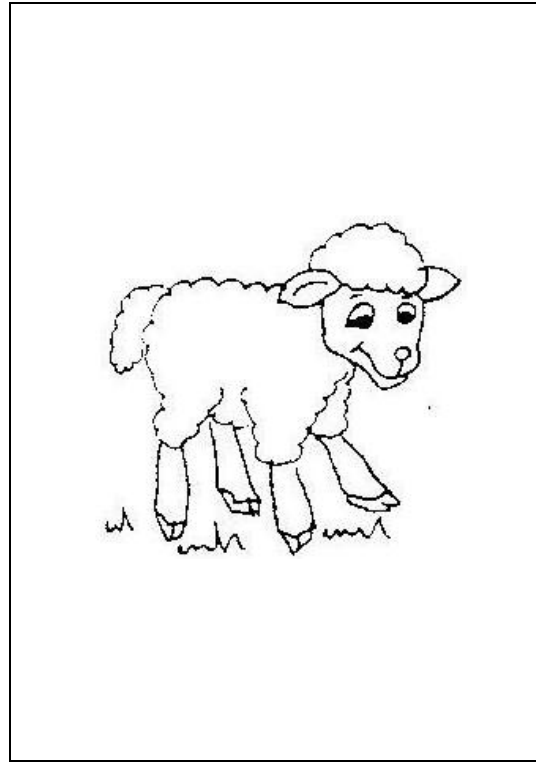
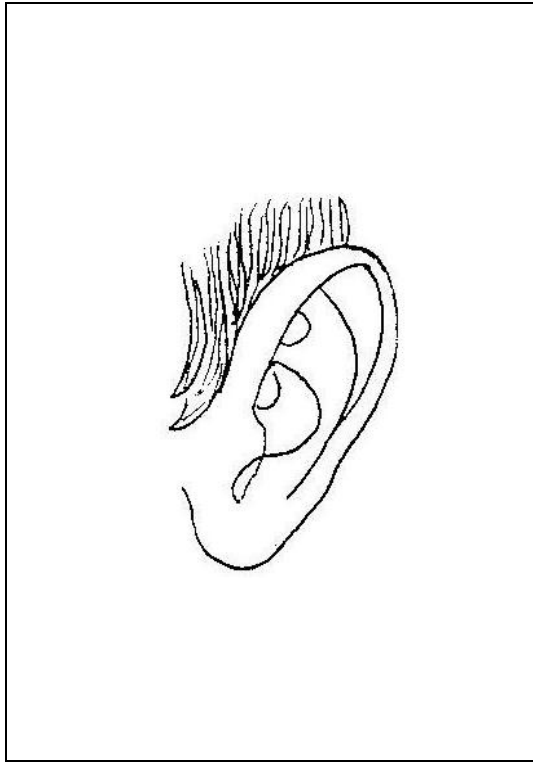

44

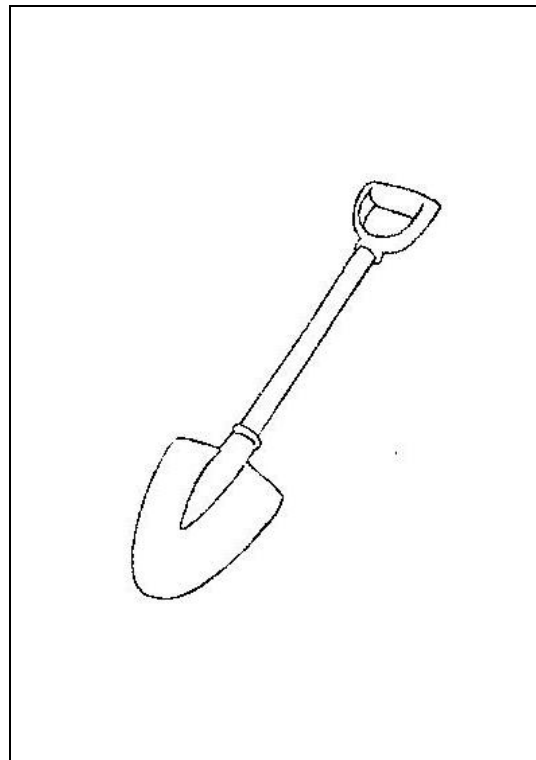
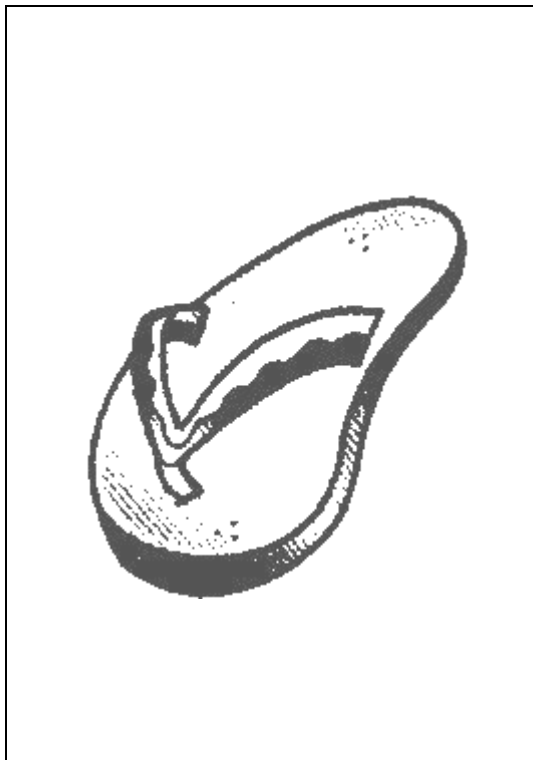

16

[Escribir texto]

Osorio- Nanjarí- Fonoaudiología

[Escribir texto]

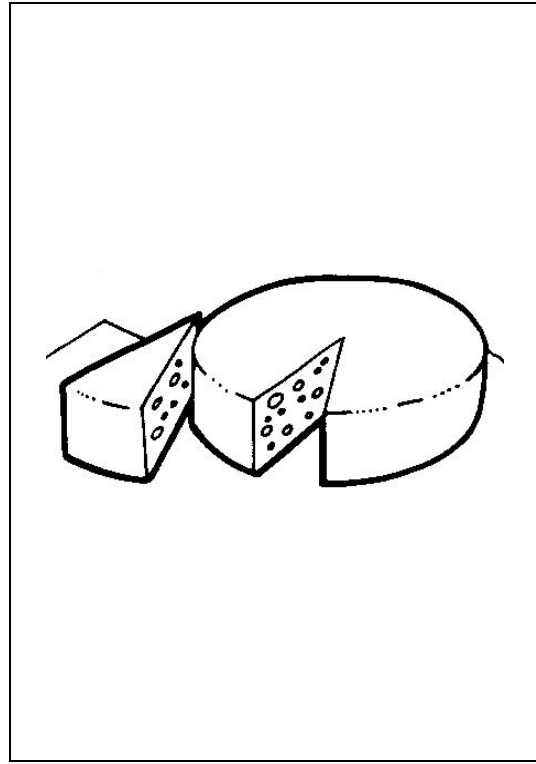

10

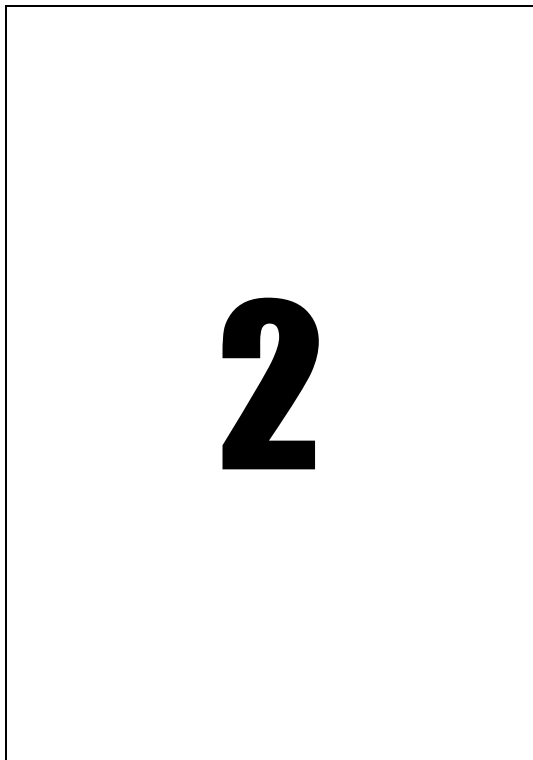

26

[Escribir texto]

Osorio- Nanjarí- Fonoaudiología

[Escribir texto]

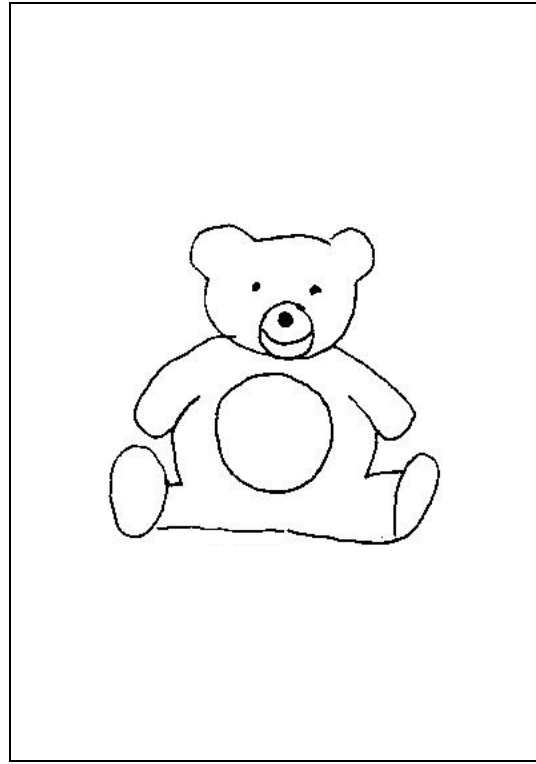
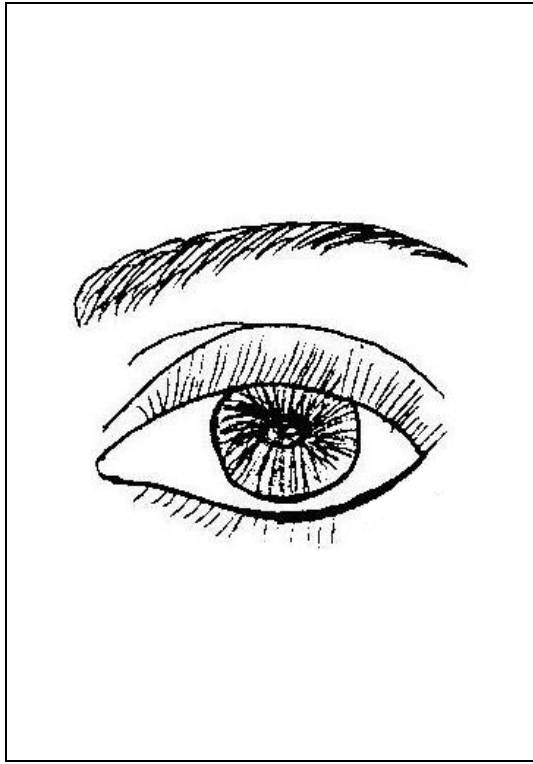

37

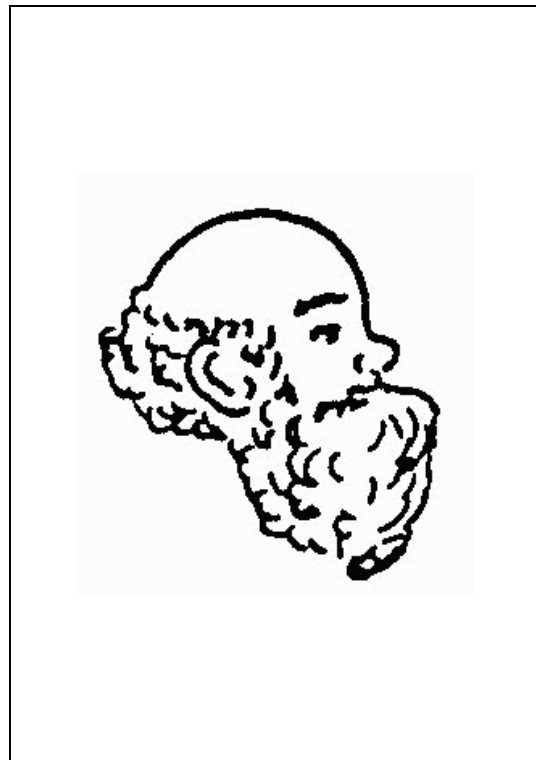
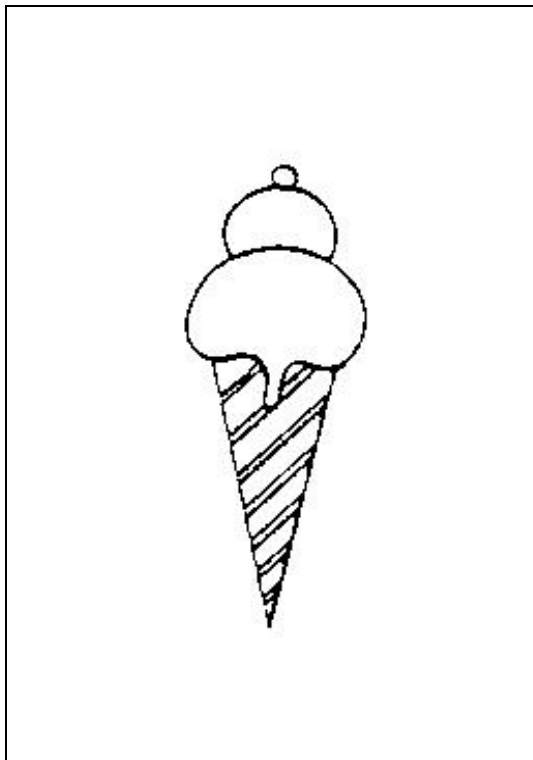

76

[Escribir texto]

Osorio- Nanjarí- Fonoaudiología

[Escribir texto]



59

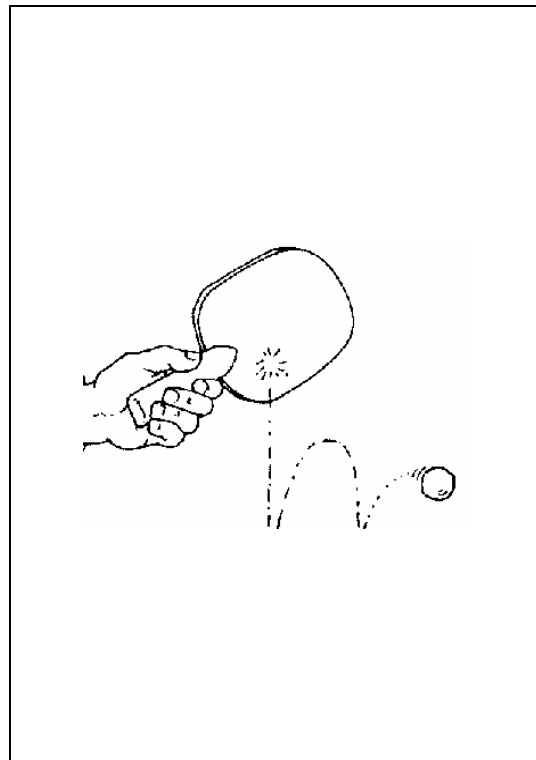

13

[Escribir texto]

Osorio- Nanjarí- Fonoaudiología

[Escribir texto]



4

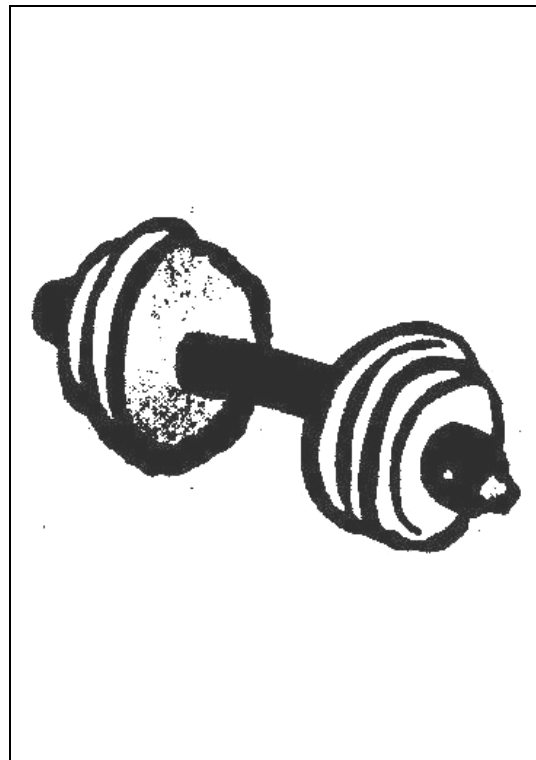
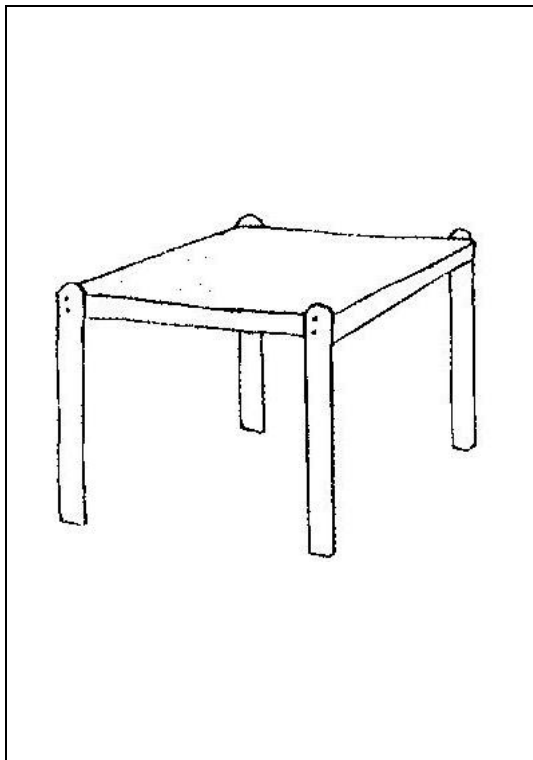

14

[Escribir texto]

Osorio- Nanjarí- Fonoaudiología

[Escribir texto]

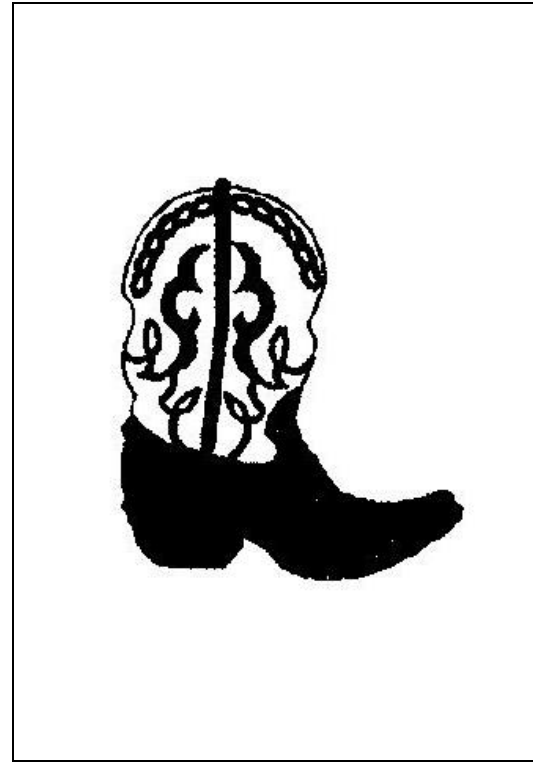
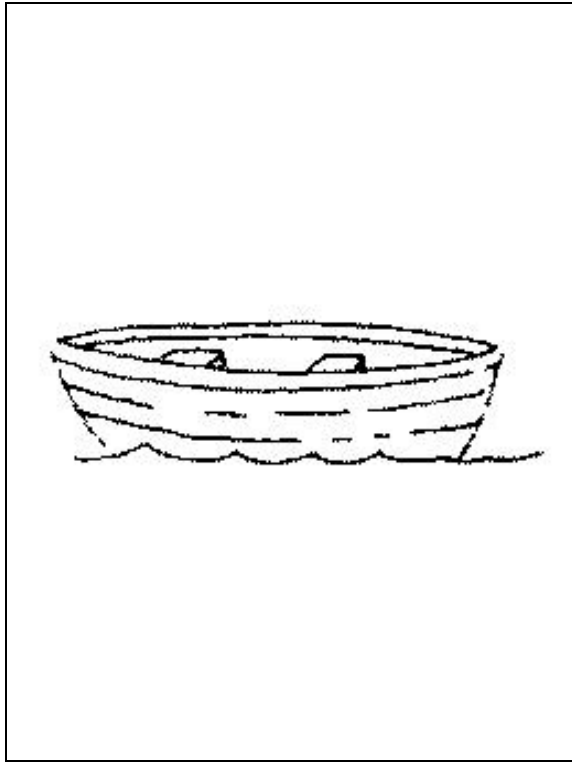

64

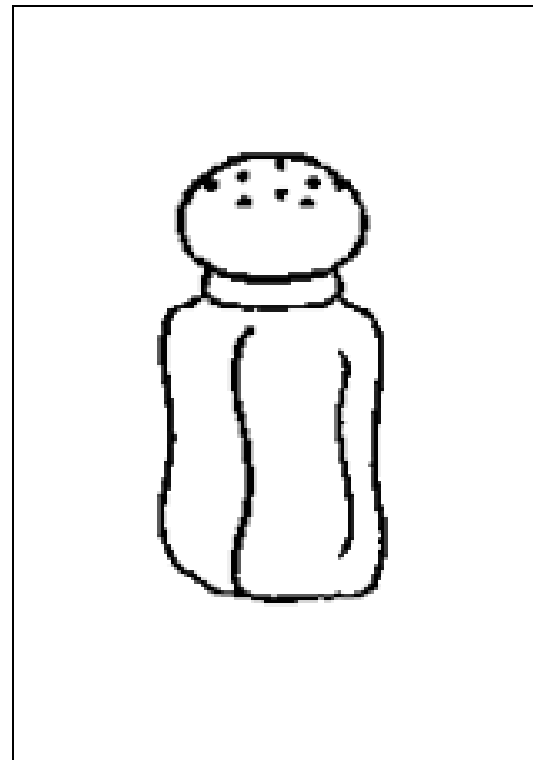
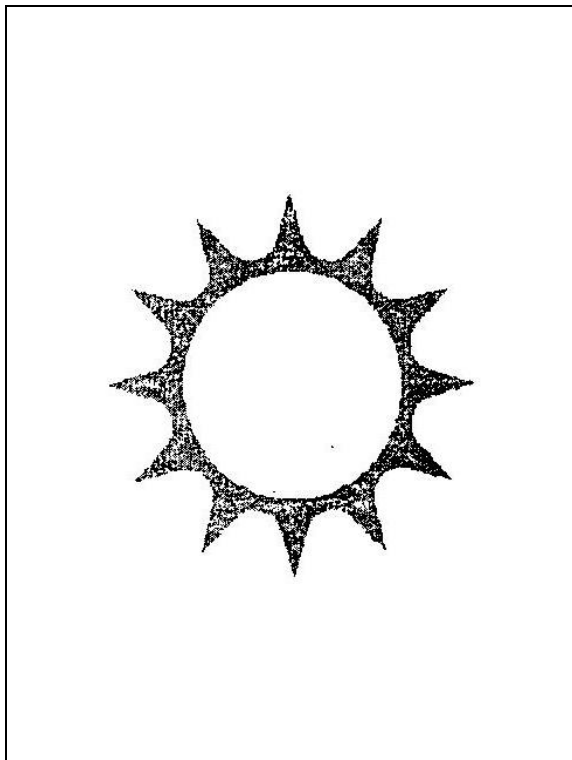

60

[Escribir texto]

Osorio- Nanjarí- Fonoaudiología

[Escribir texto]

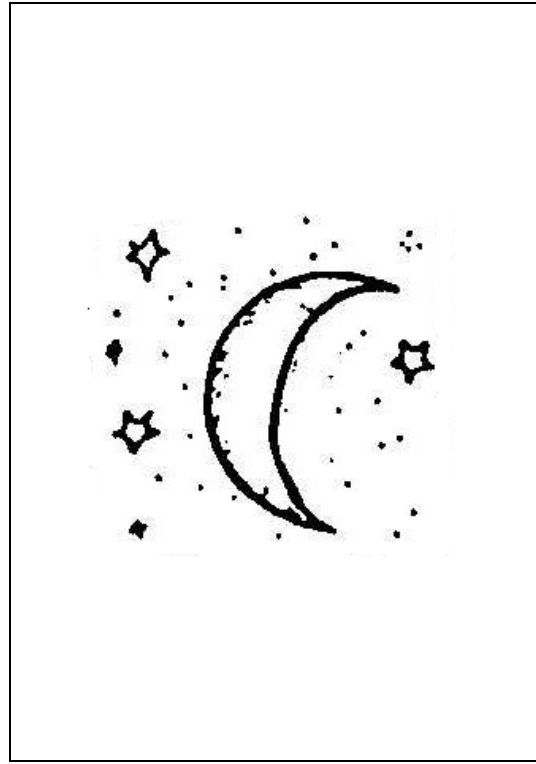

42

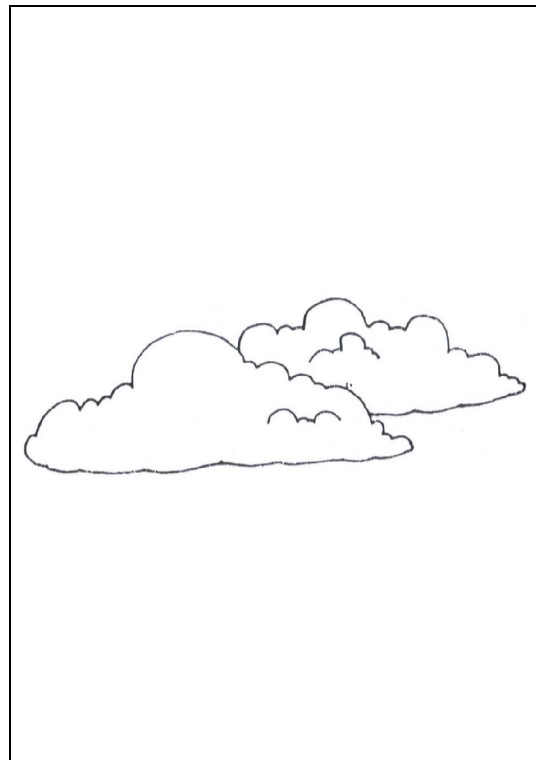

32

[Escribir texto]

Osorio- Nanjarí- Fonoaudiología

[Escribir texto]



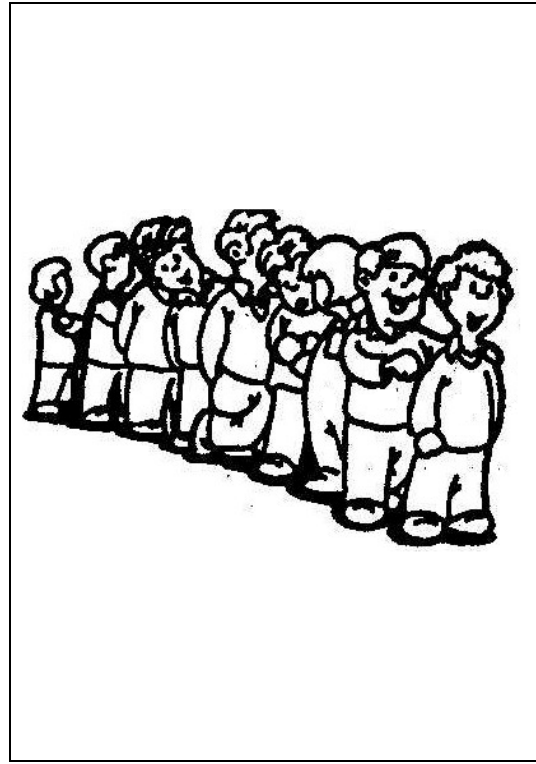
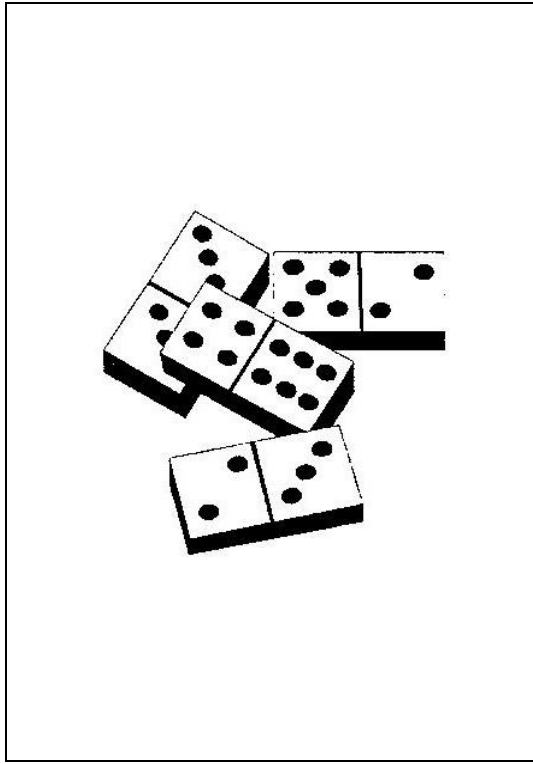

40

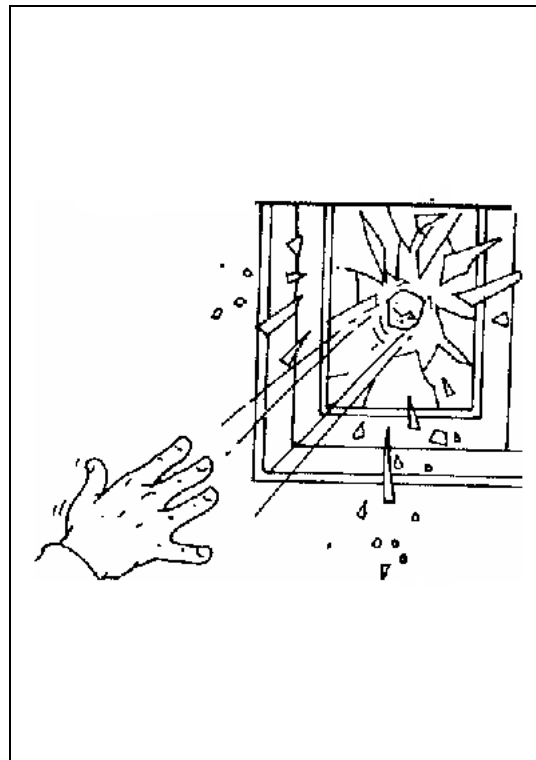
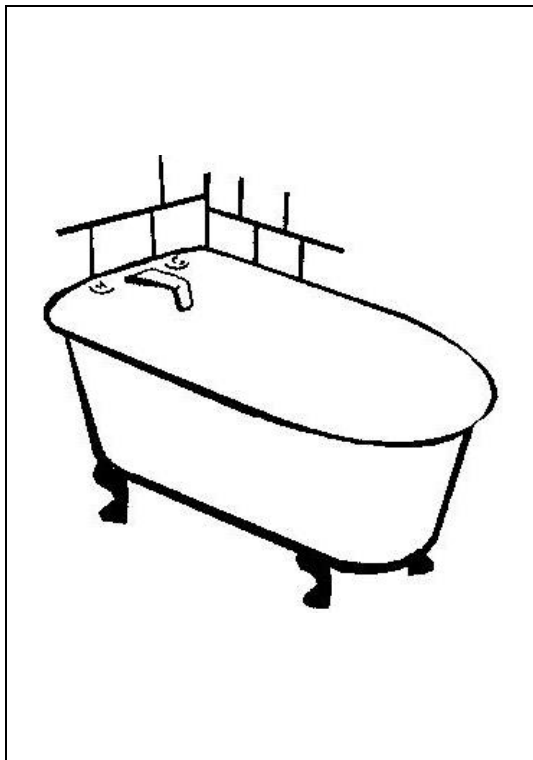

47

[Escribir texto]

Osorio- Nanjarí- Fonoaudiología

[Escribir texto]

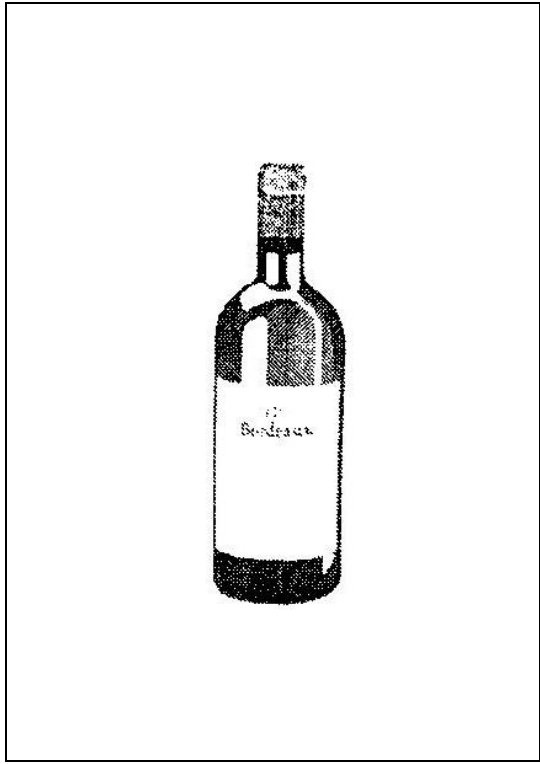

9

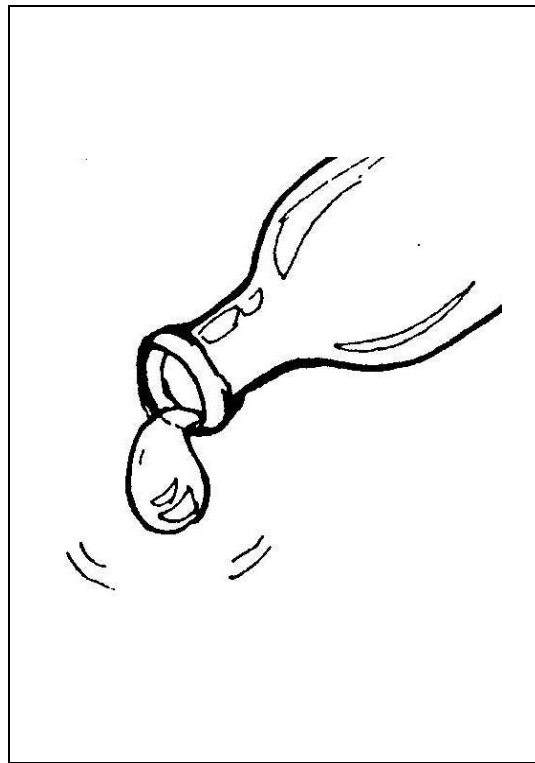
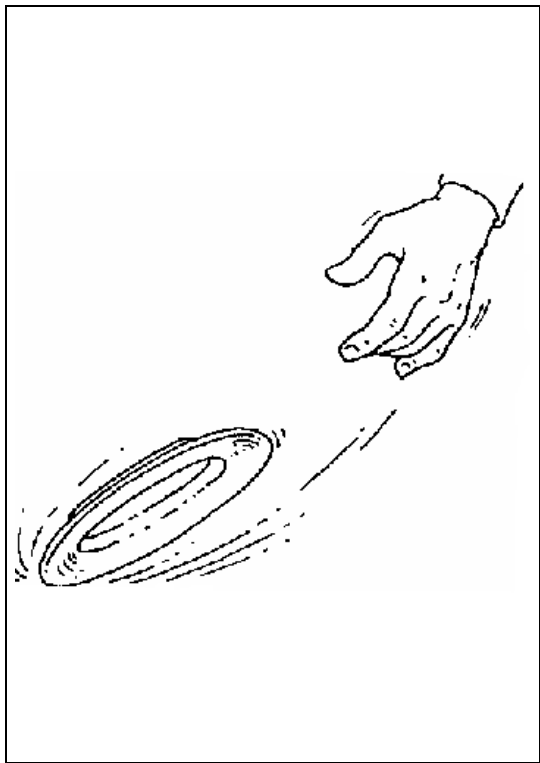

11

[Escribir texto]

Osorio- Nanjarí- Fonoaudiología

[Escribir texto]

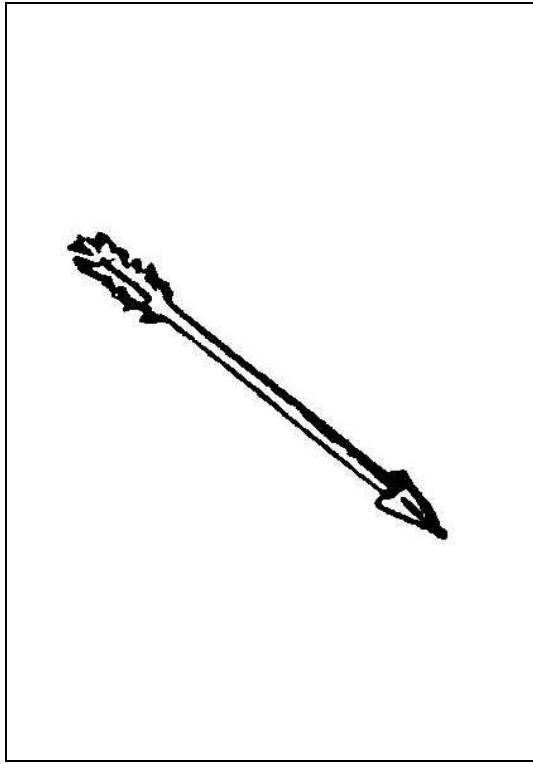

71

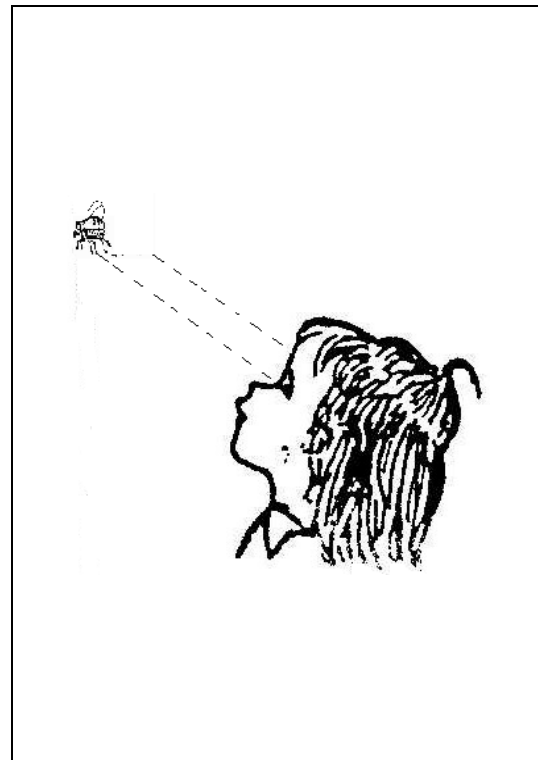
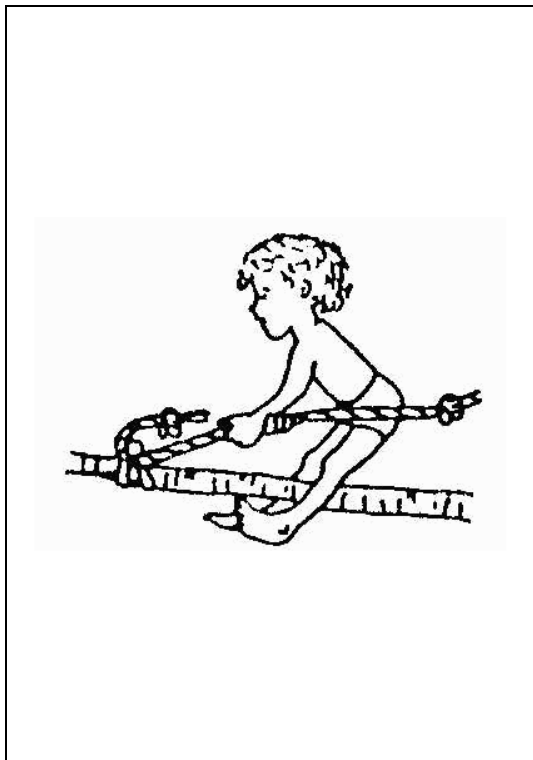

22

[Escribir texto]

Osorio- Nanjarí- Fonoaudiología

[Escribir texto]

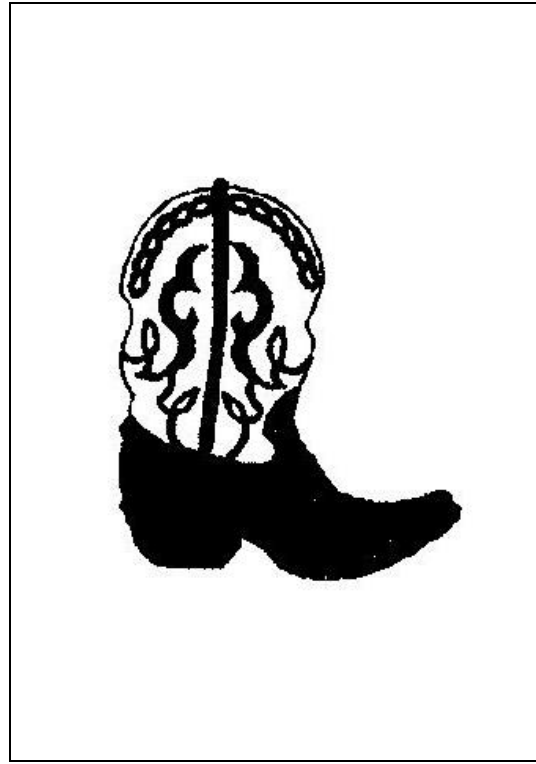

25

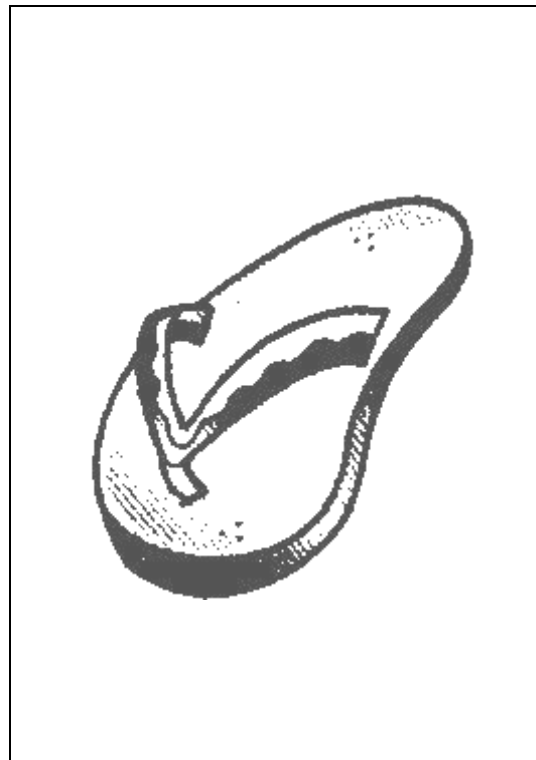
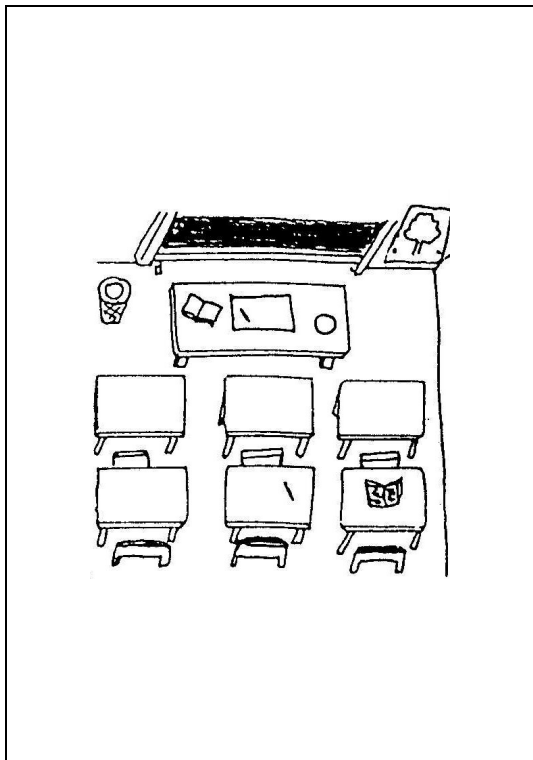

34

[Escribir texto]

Osorio- Nanjarí- Fonoaudiología

[Escribir texto]

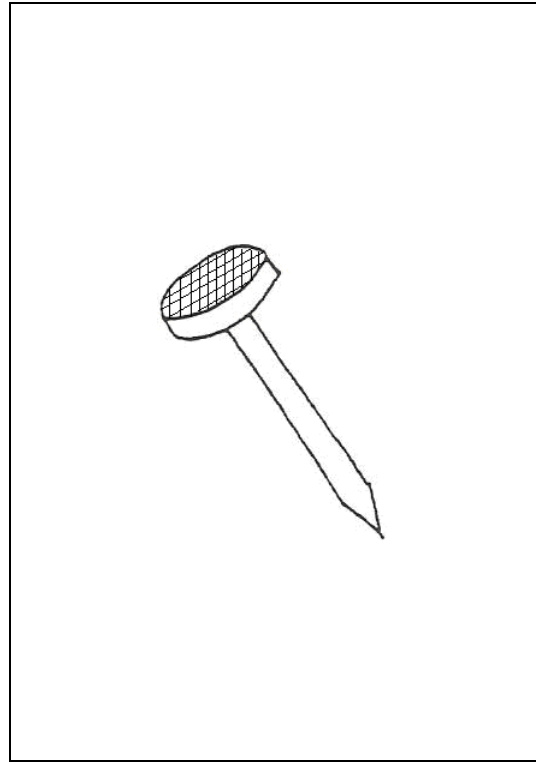
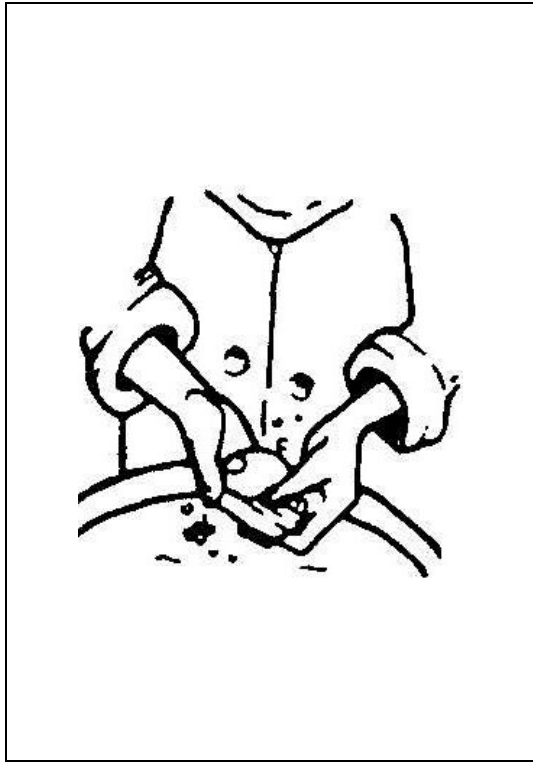

74

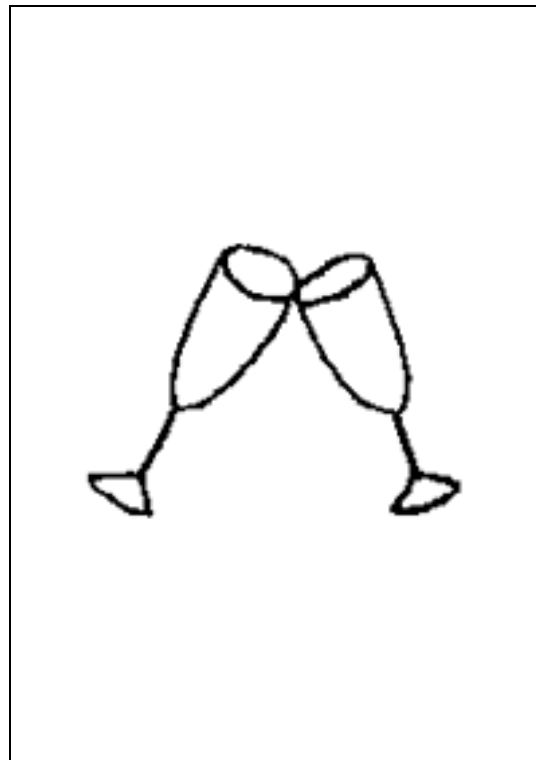
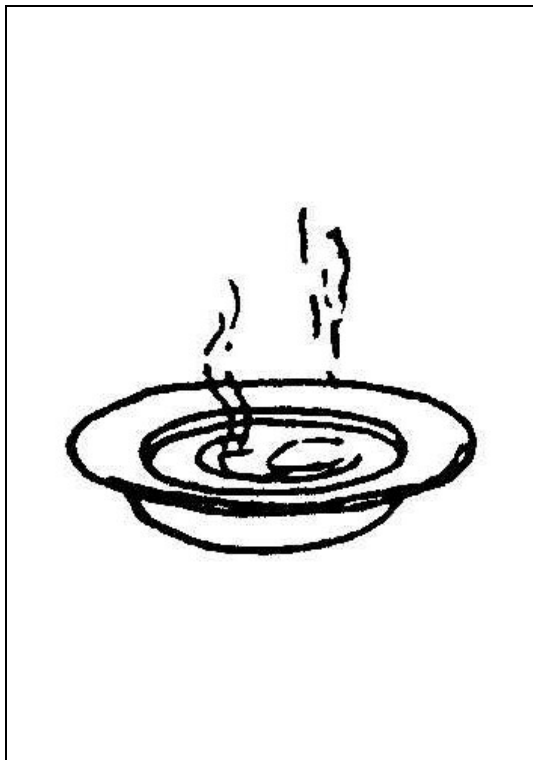

35

[Escribir texto]

Osorio- Nanjarí- Fonoaudiología

[Escribir texto]

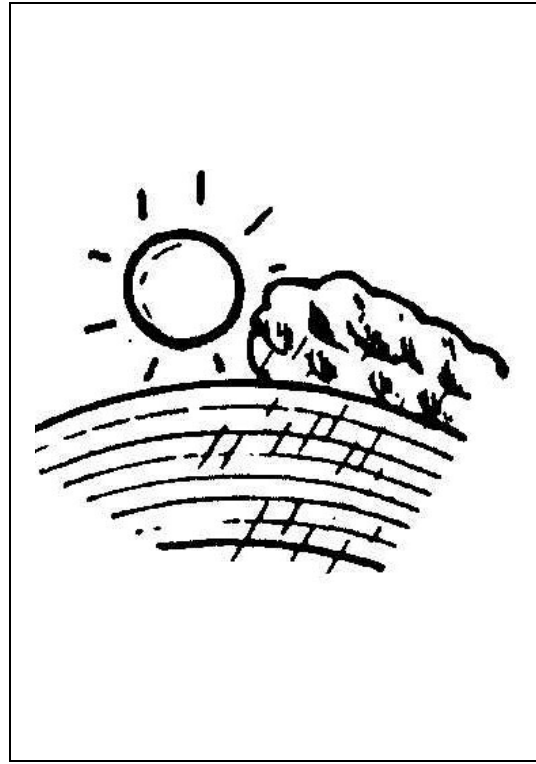
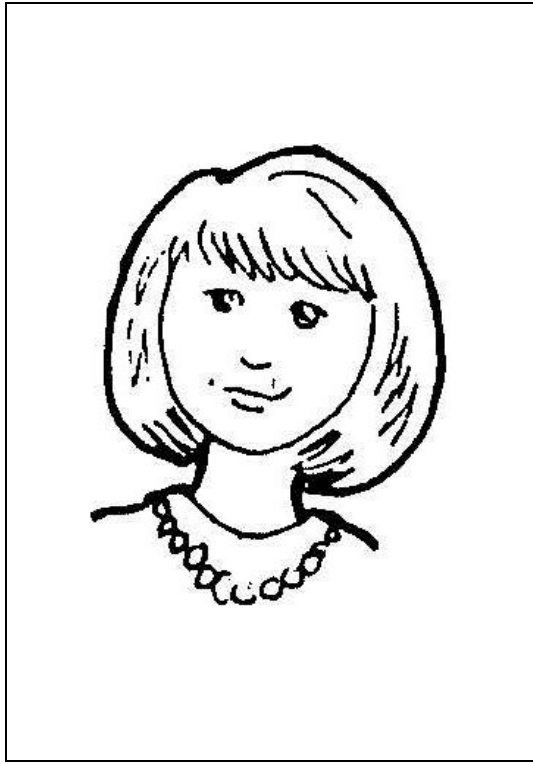

24

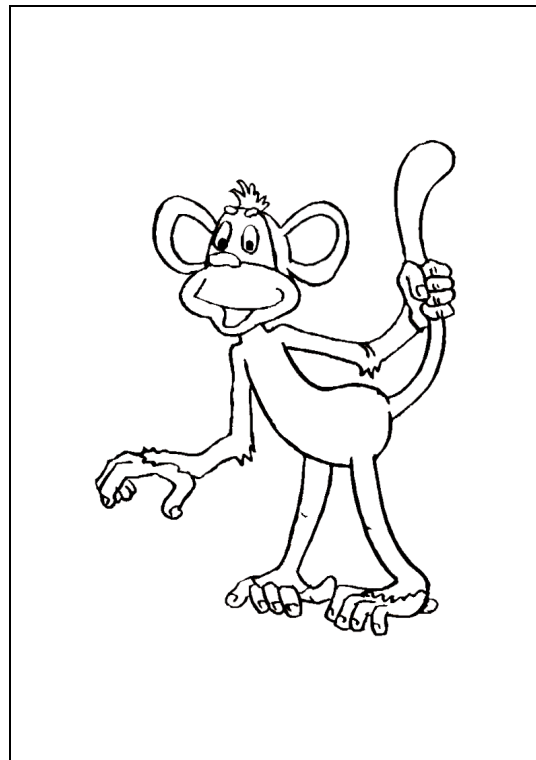
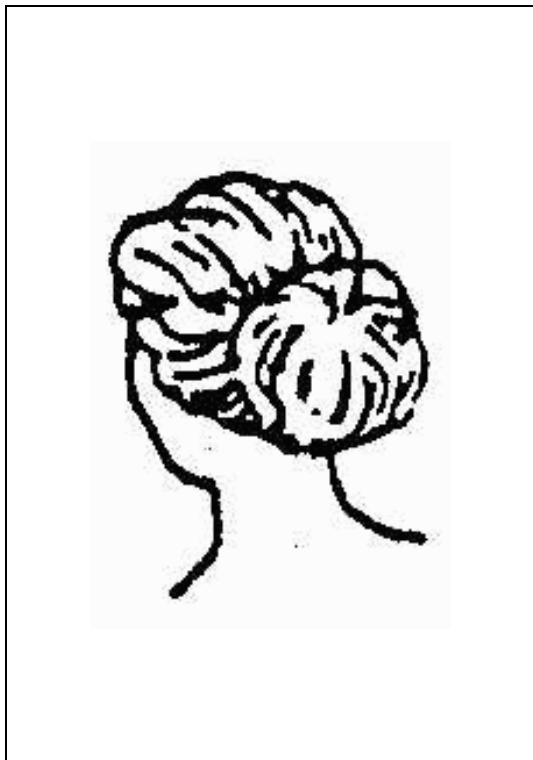

38

[Escribir texto]

Osorio- Nanjarí- Fonoaudiología

[Escribir texto]

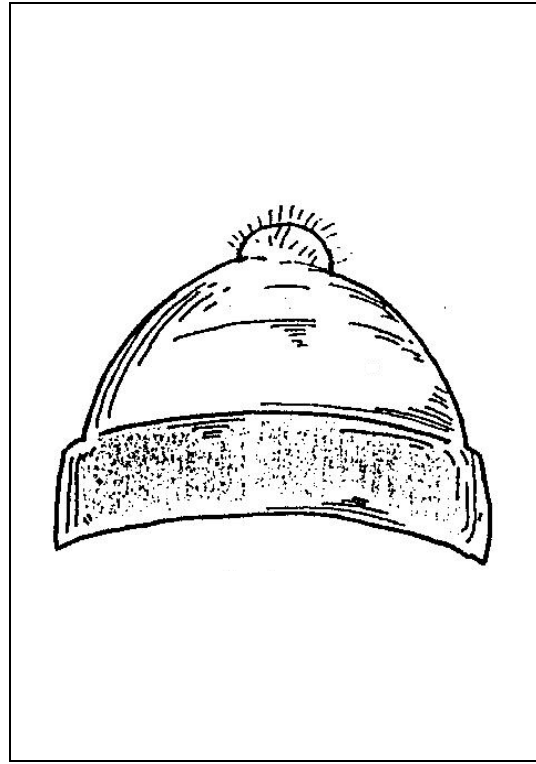

36

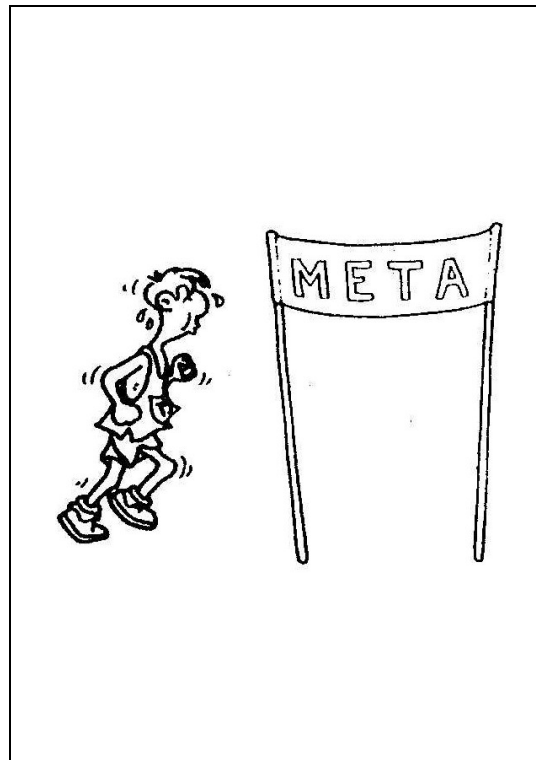
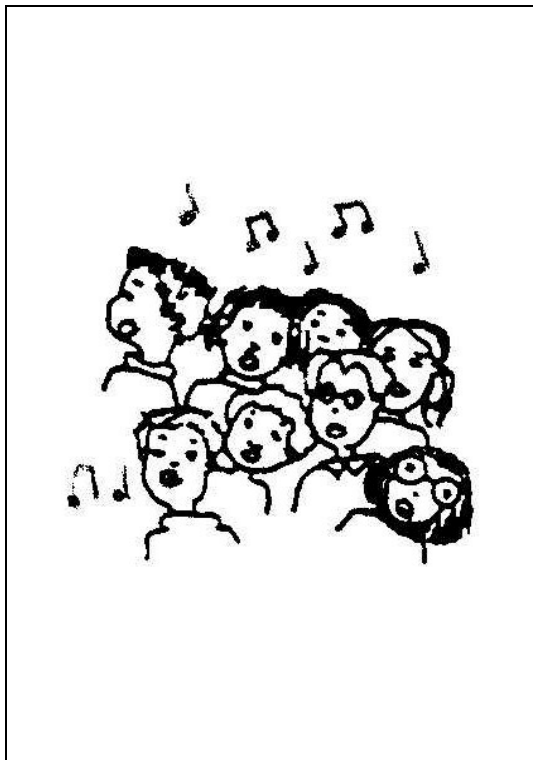

50

[Escribir texto]

Osorio- Nanjarí- Fonoaudiología

[Escribir texto]

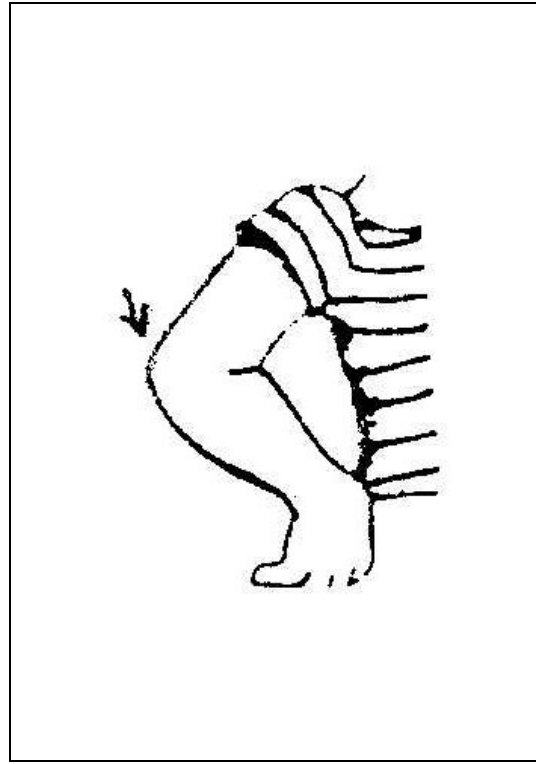
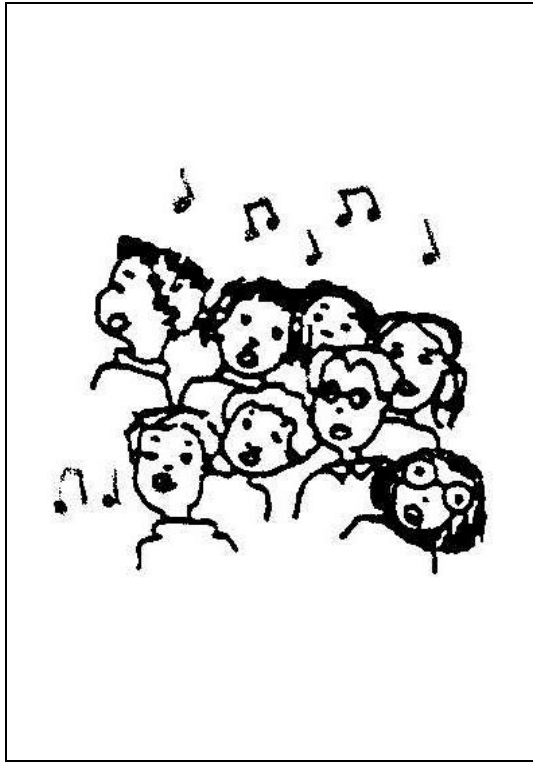

45

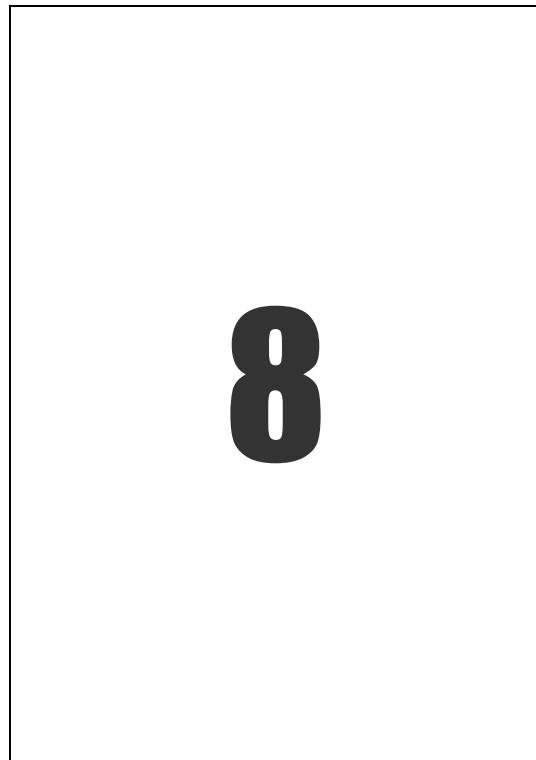
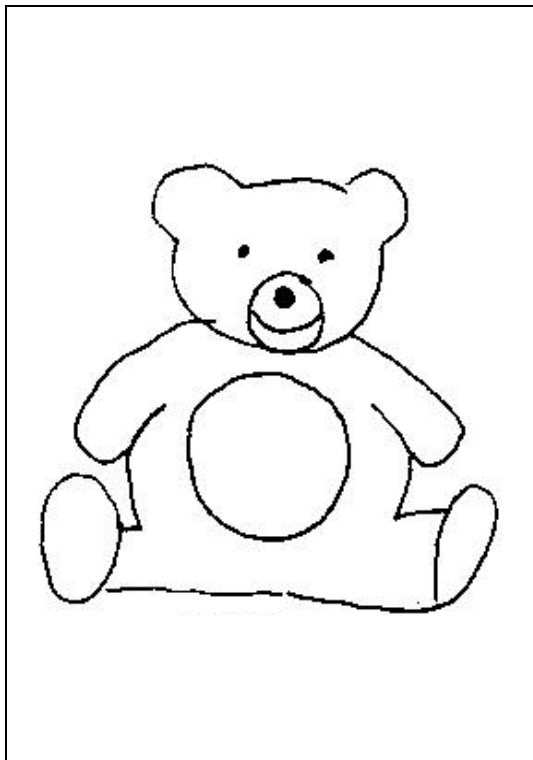

33

[Escribir texto]

Osorio- Nanjarí- Fonoaudiología

[Escribir texto]



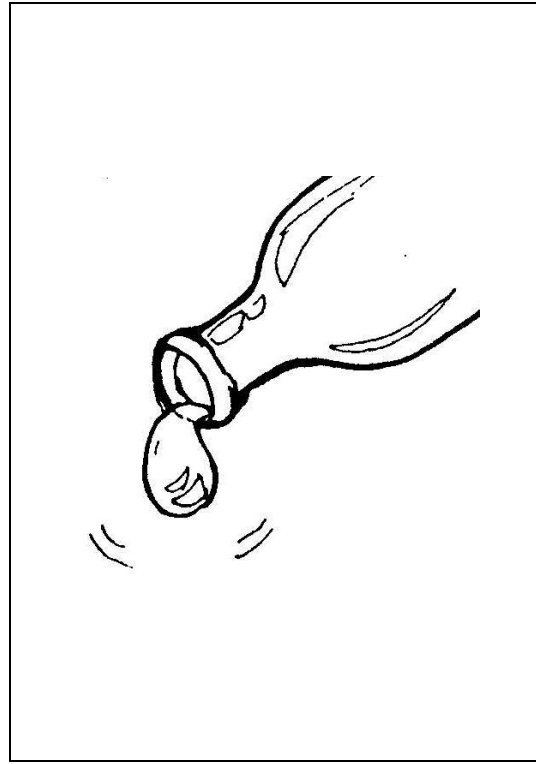
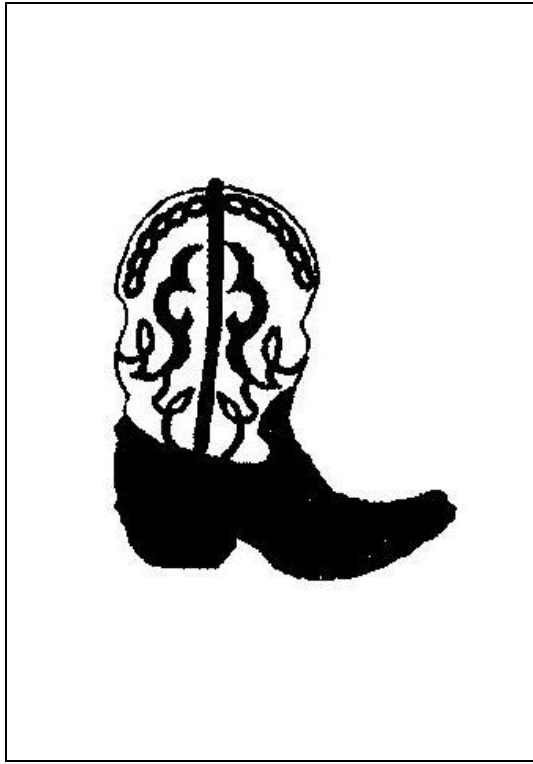

11

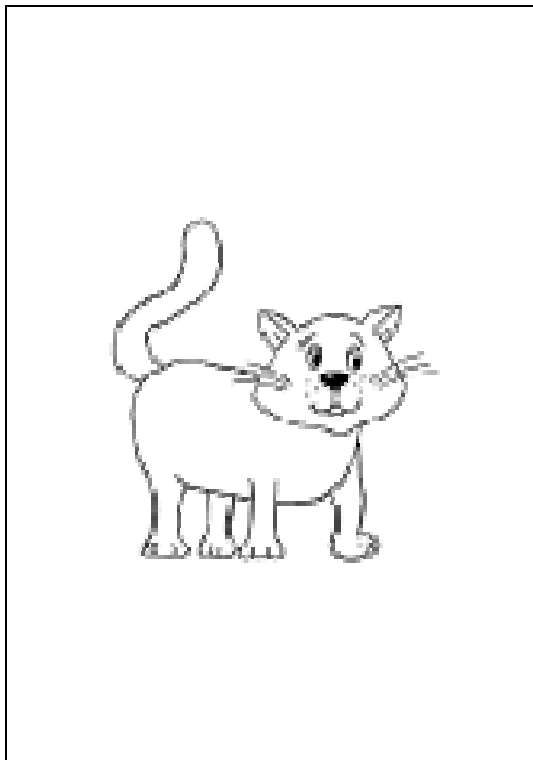

12

[Escribir texto]

Osorio- Nanjarí- Fonoaudiología

[Escribir texto]

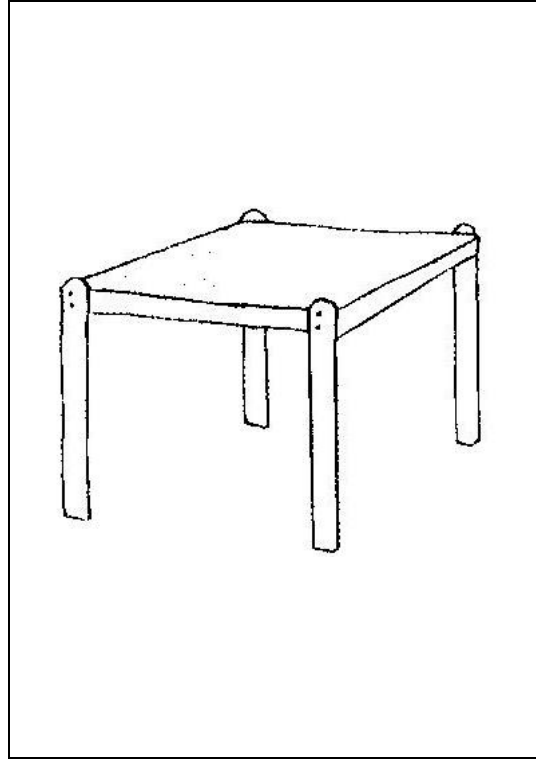

5

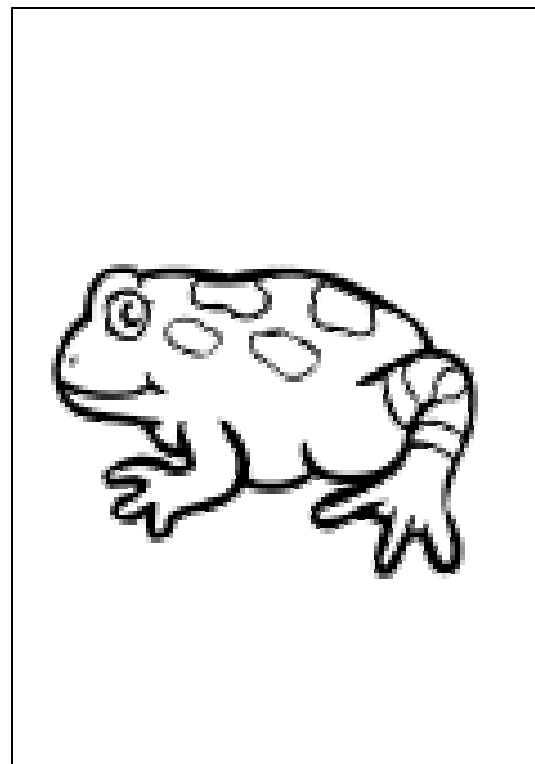
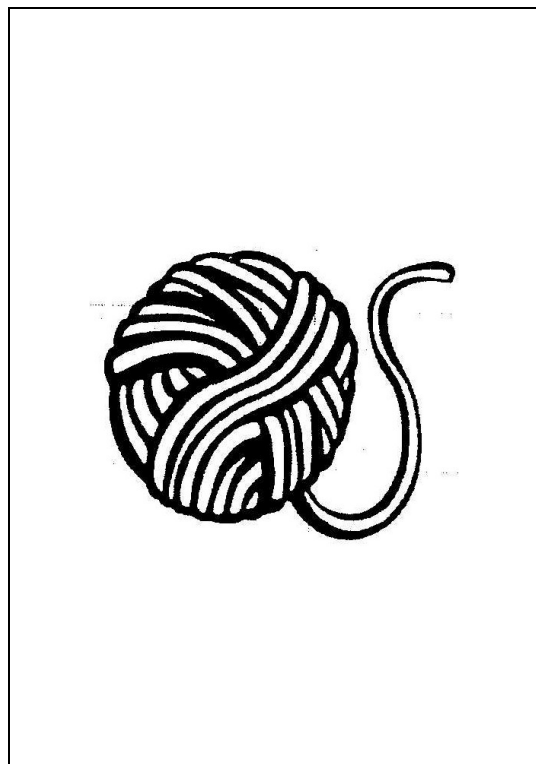

55

[Escribir texto]

Osorio- Nanjarí- Fonoaudiología

[Escribir texto]

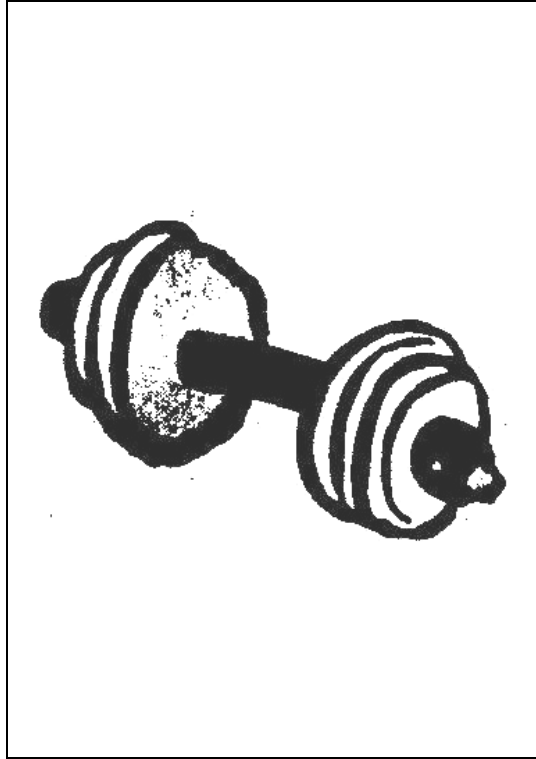

1

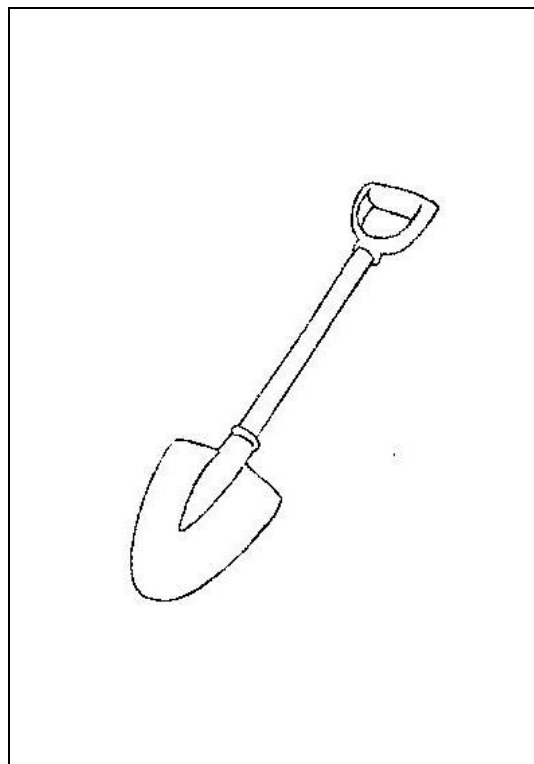
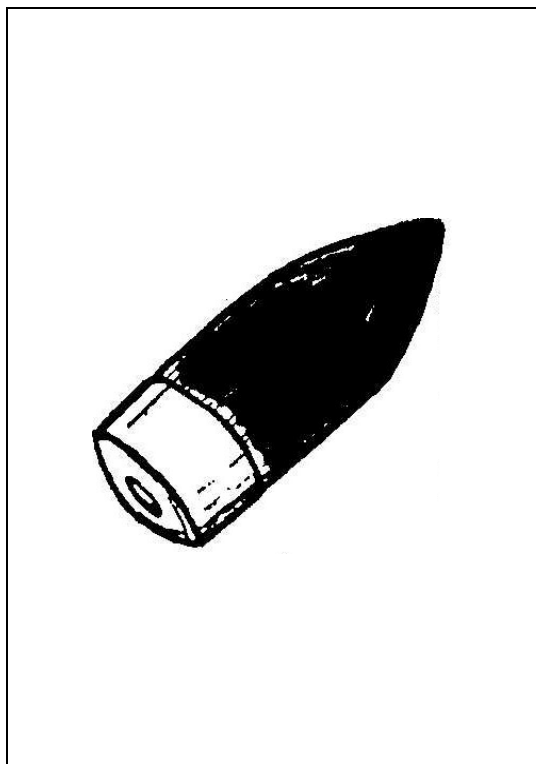

2

[Escribir texto]

Osorio- Nanjarí- Fonoaudiología

[Escribir texto]

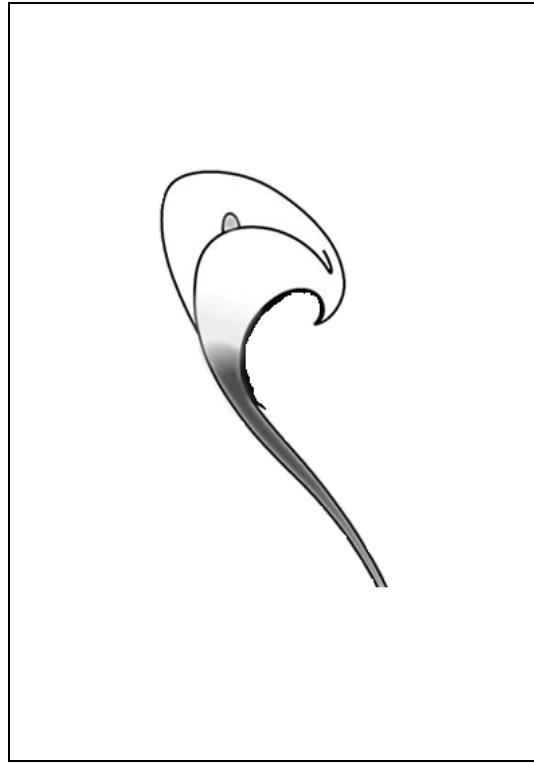
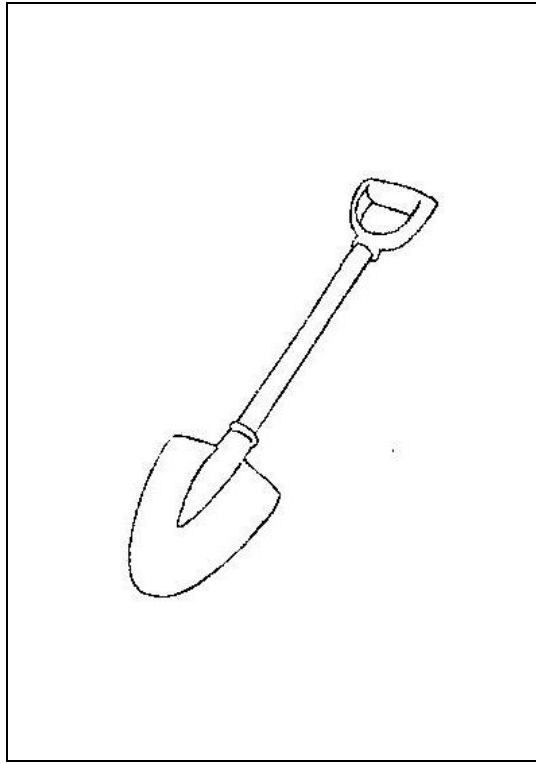

17

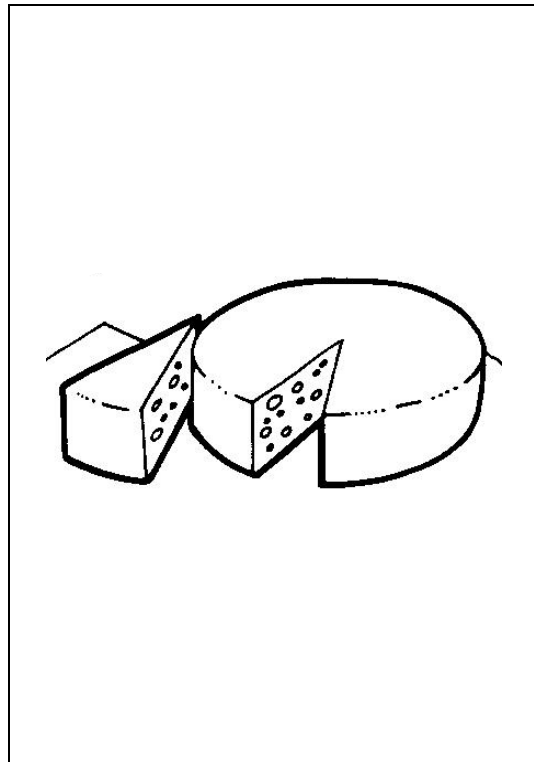
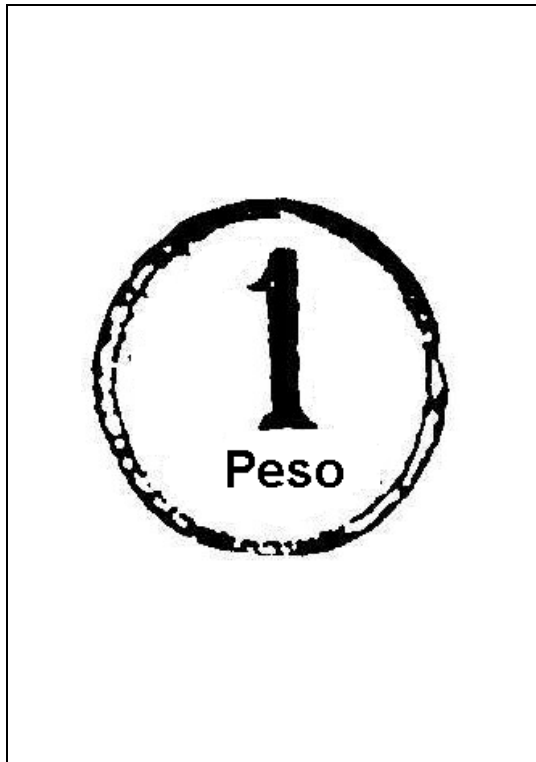

18

[Escribir texto]

Osorio- Nanjarí- Fonoaudiología

[Escribir texto]

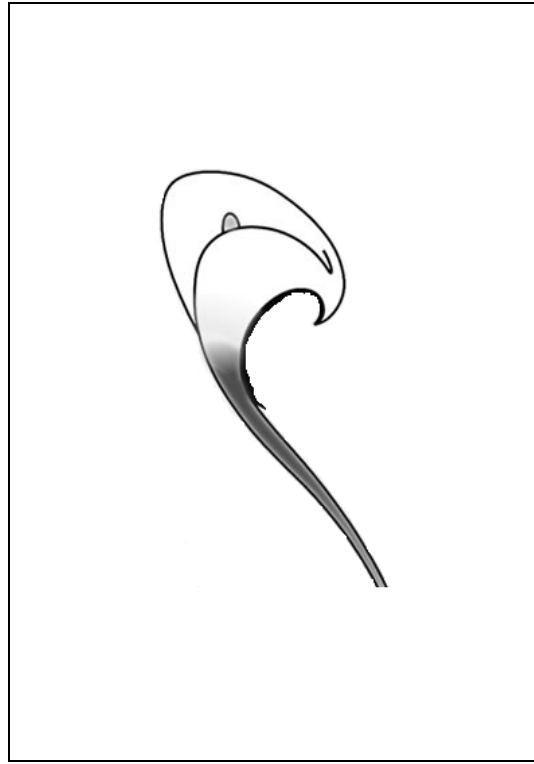
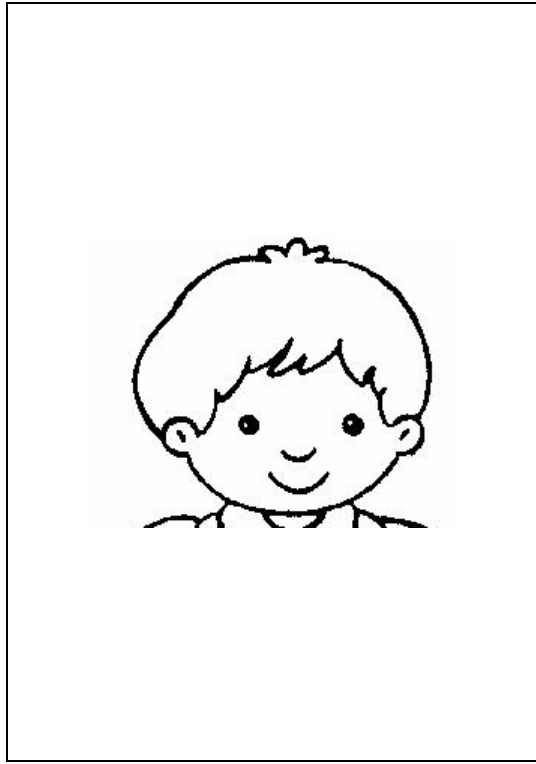

48

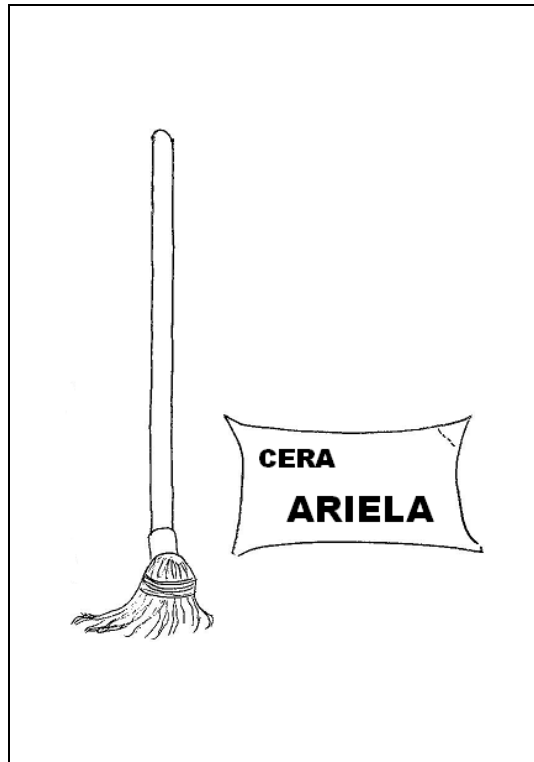
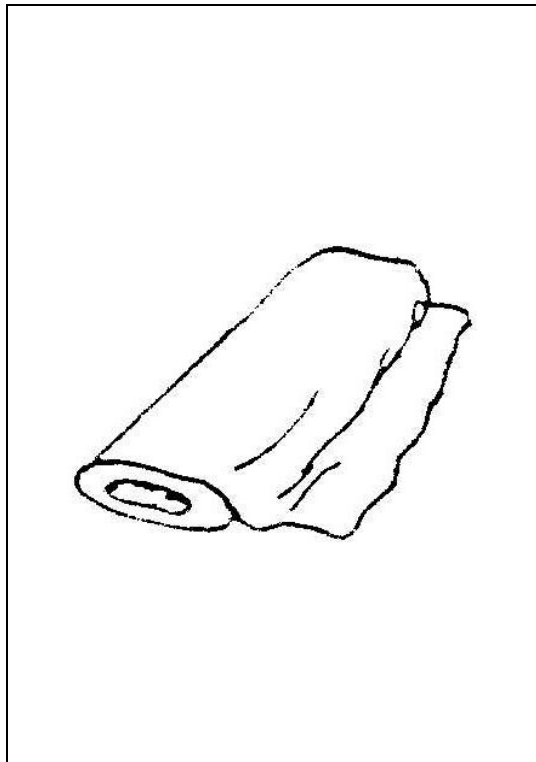

46

[Escribir texto]

Osorio- Nanjarí- Fonoaudiología

[Escribir texto]

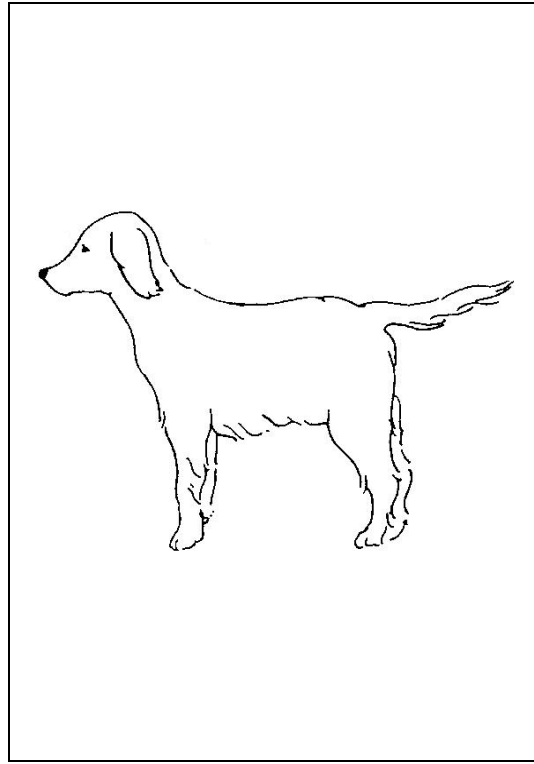

54

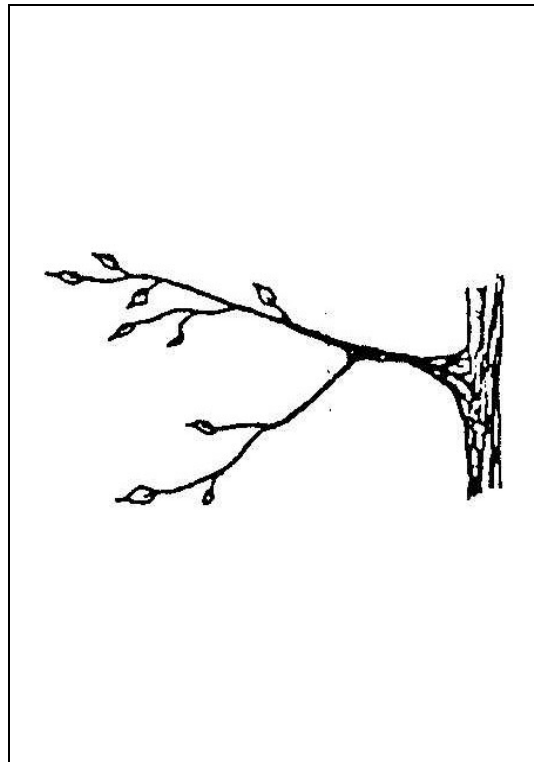

53

[Escribir texto]

Osorio- Nanjarí- Fonoaudiología

[Escribir texto]

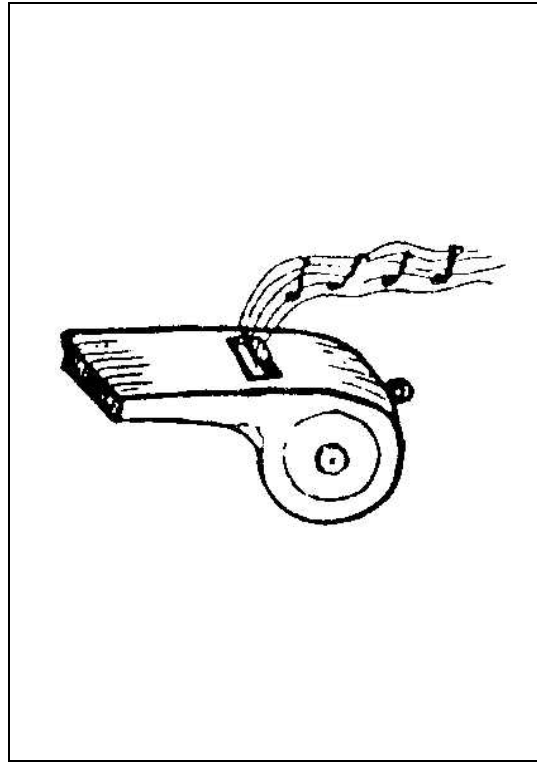
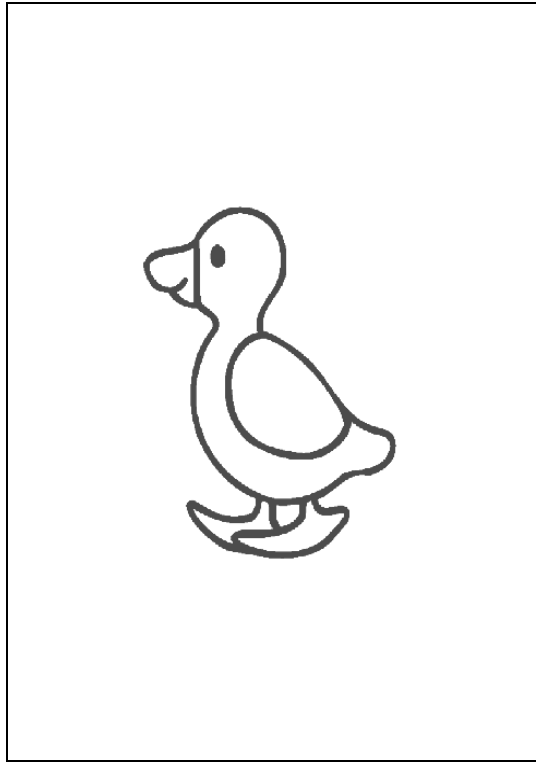

66

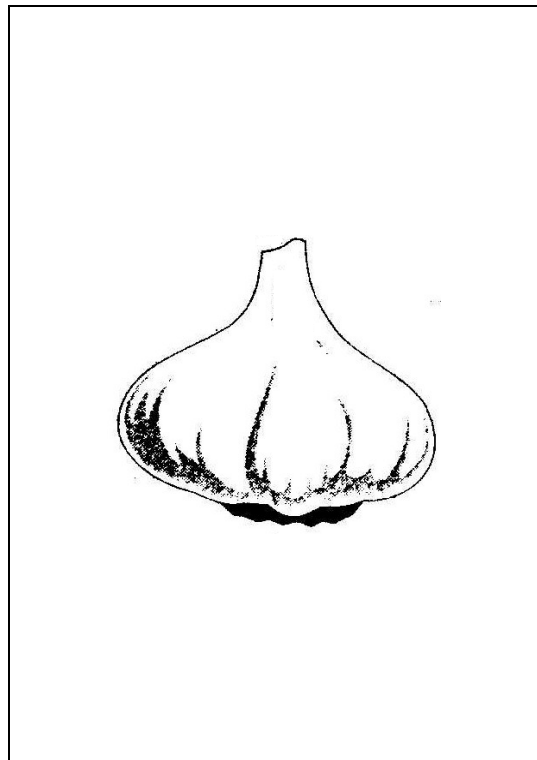
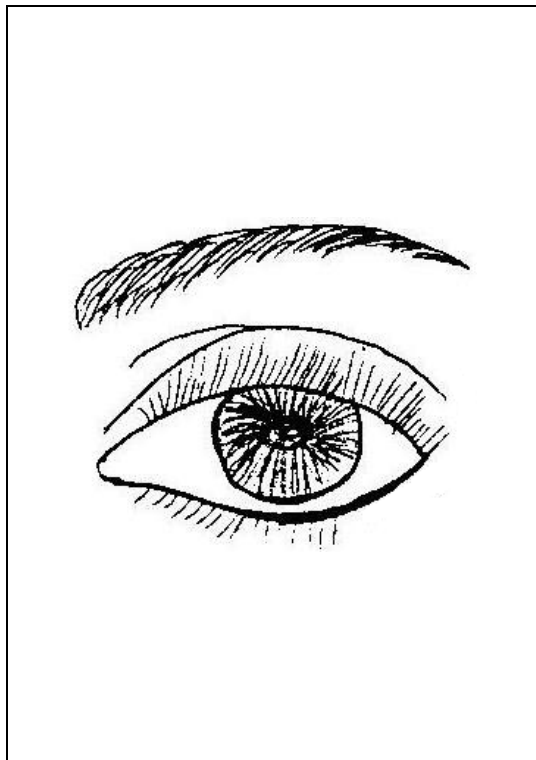

58

[Escribir texto]

Osorio- Nanjarí- Fonoaudiología

[Escribir texto]

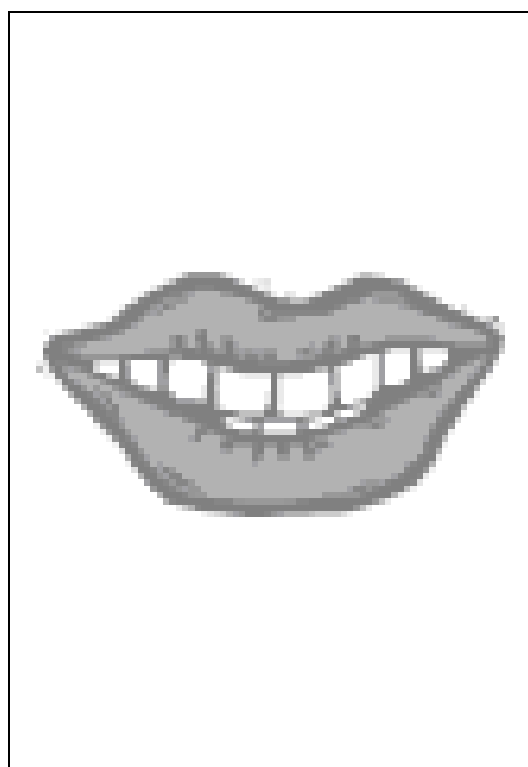
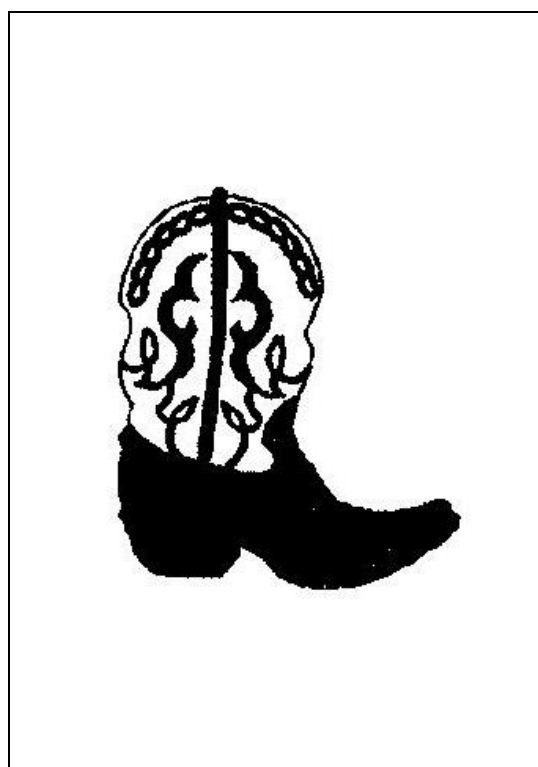

30

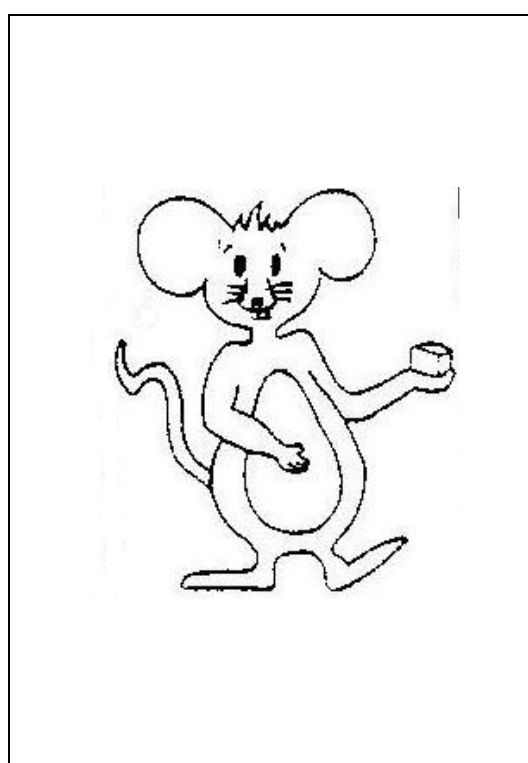
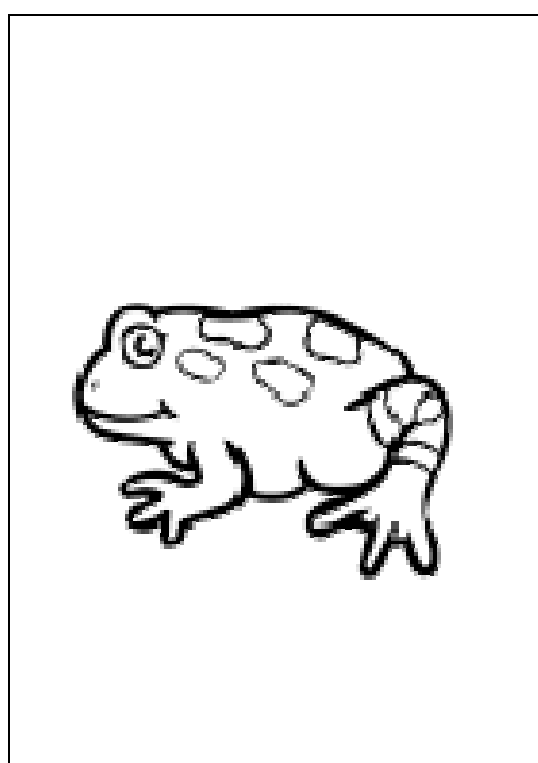

28

[Escribir texto]

Osorio- Nanjarí- Fonoaudiología

[Escribir texto]



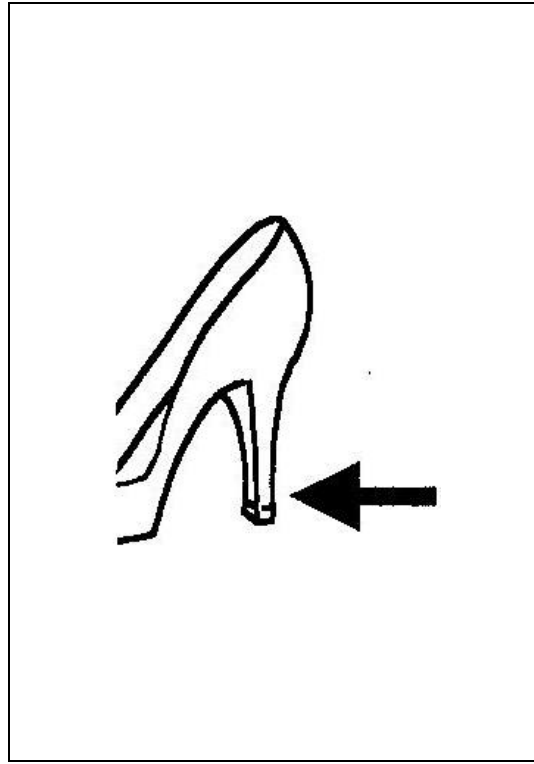
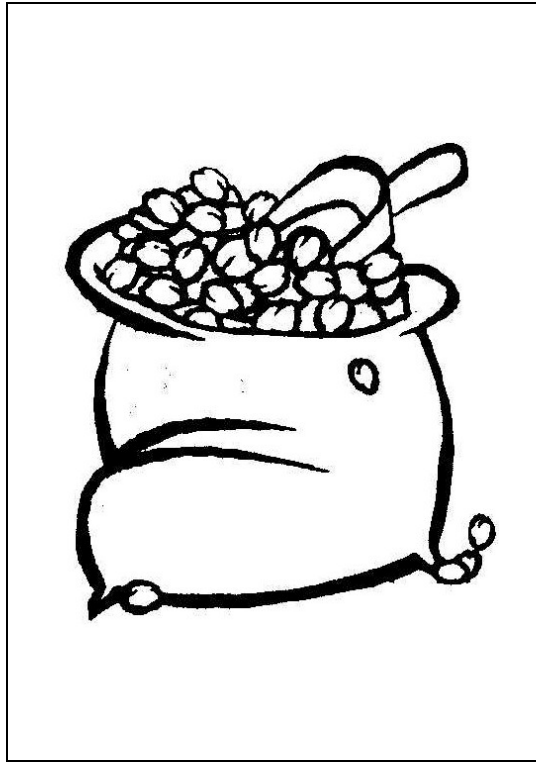

77

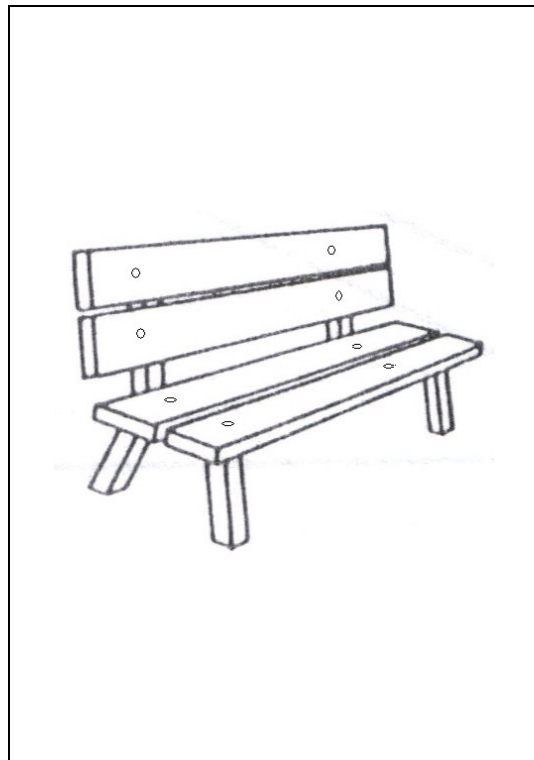
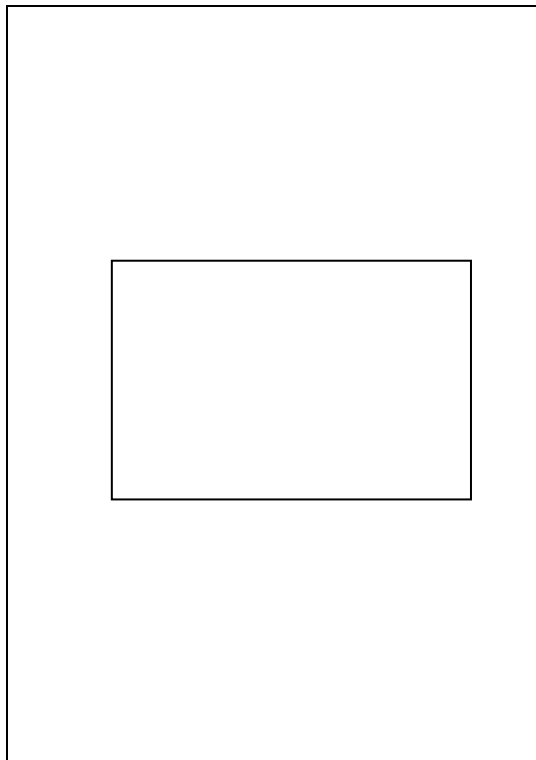

68

[Escribir texto]

Osorio- Nanjarí- Fonoaudiología

[Escribir texto]

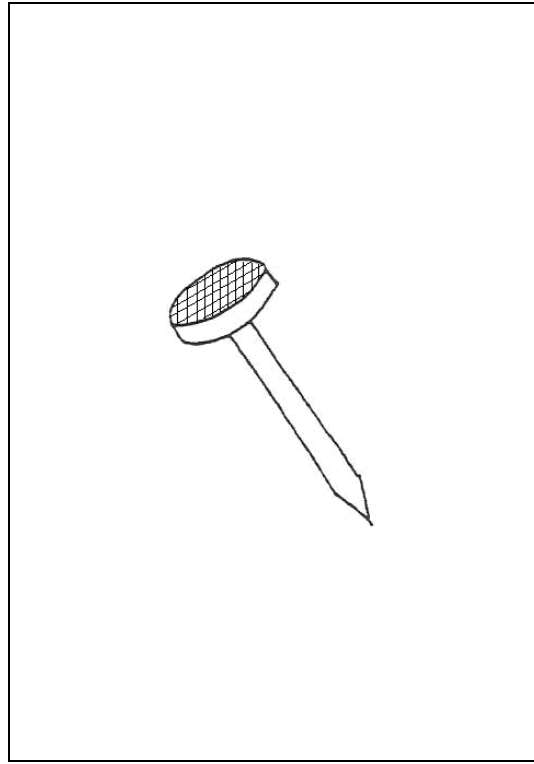
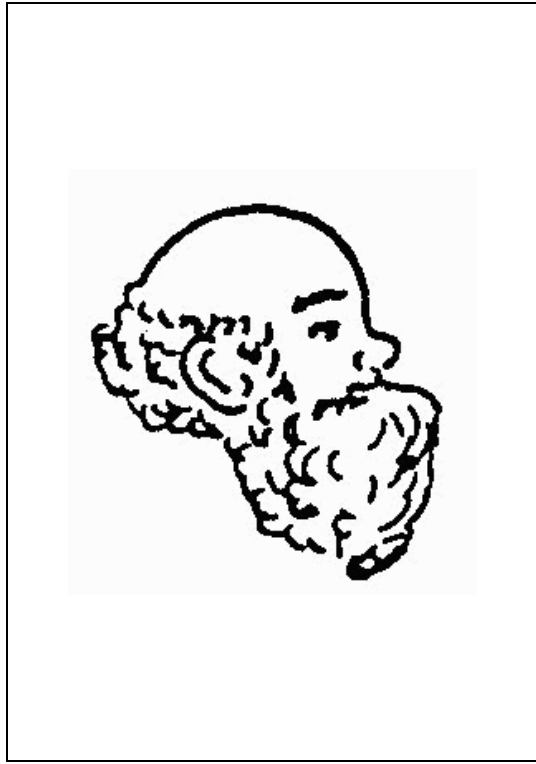

72

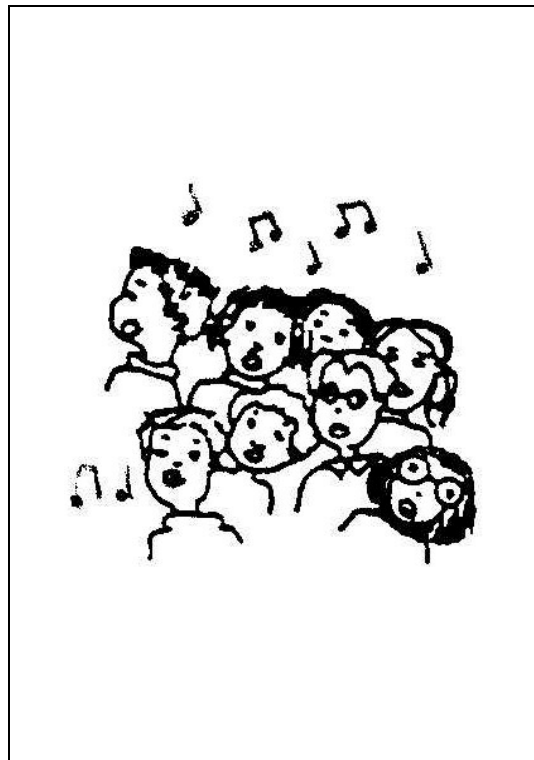

73

[Escribir texto]

Osorio- Nanjarí- Fonoaudiología

[Escribir texto]

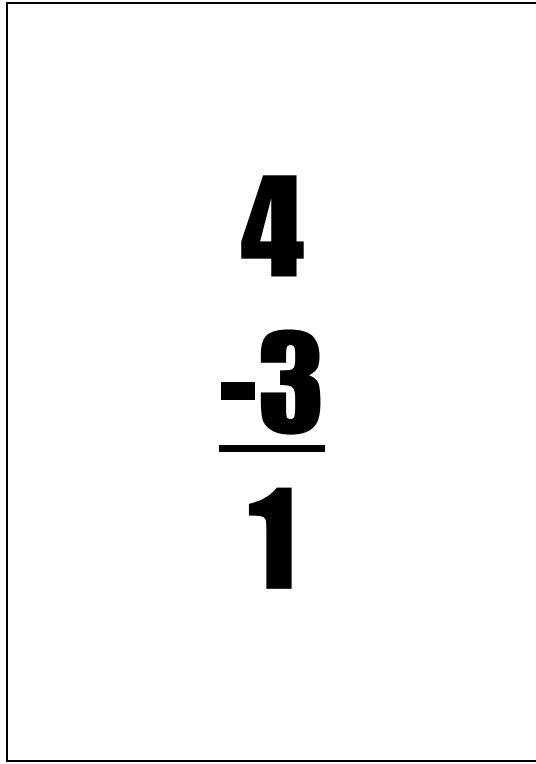

75

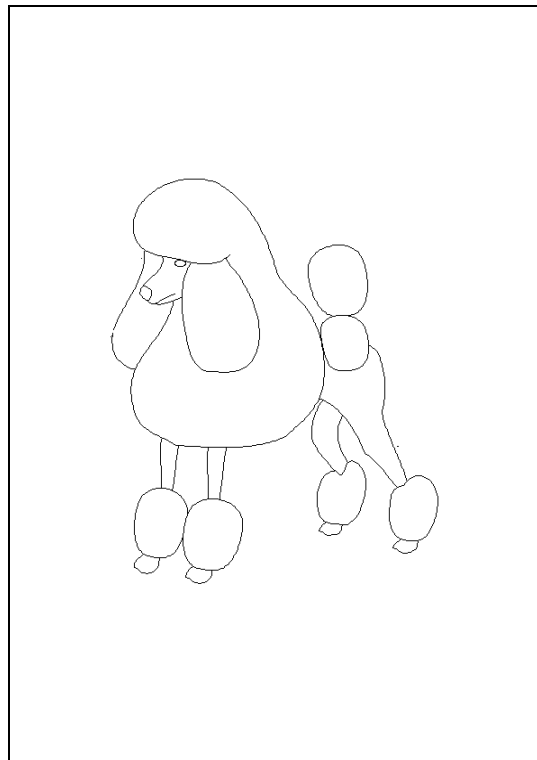
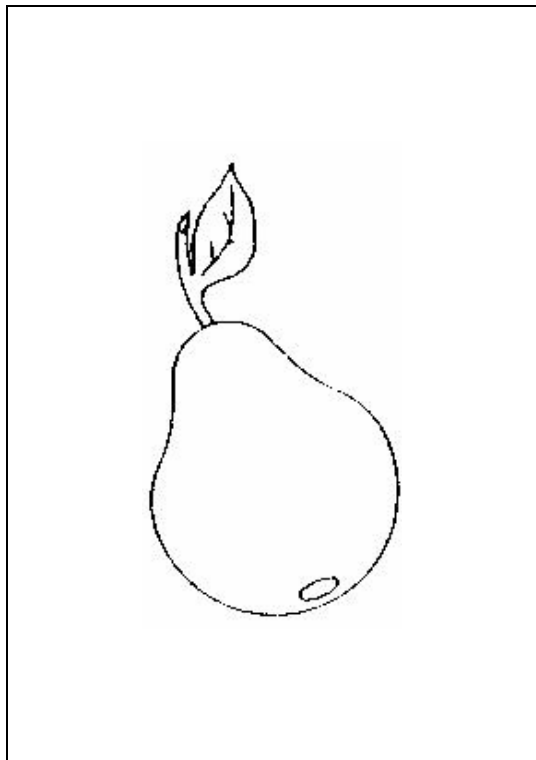

51

[Escribir texto]

Osorio- Nanjarí- Fonoaudiología

[Escribir texto]

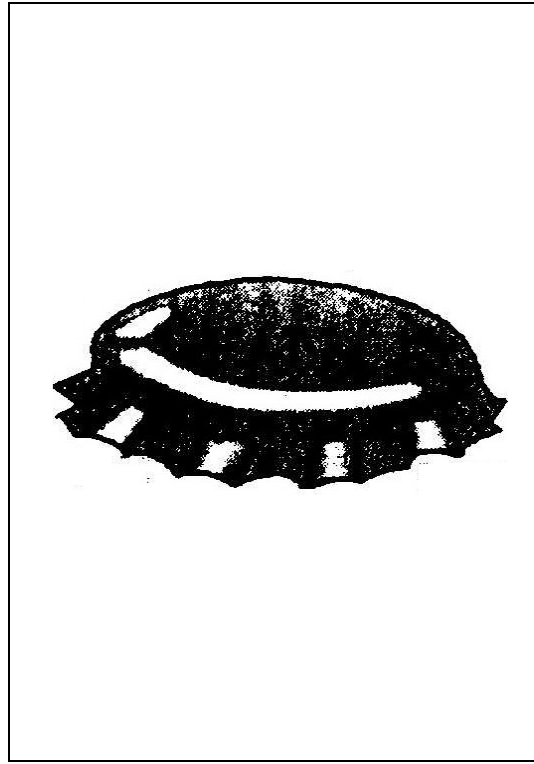

62

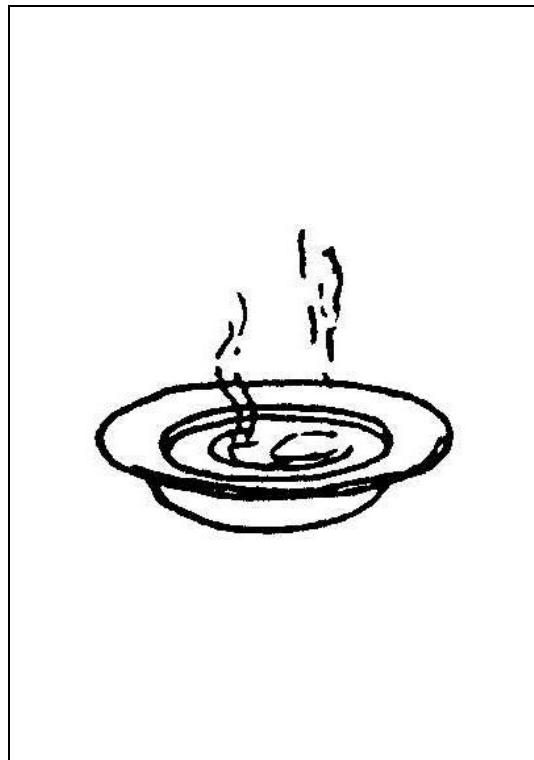

69

[Escribir texto]

Osorio- Nanjarí- Fonoaudiología

[Escribir texto]

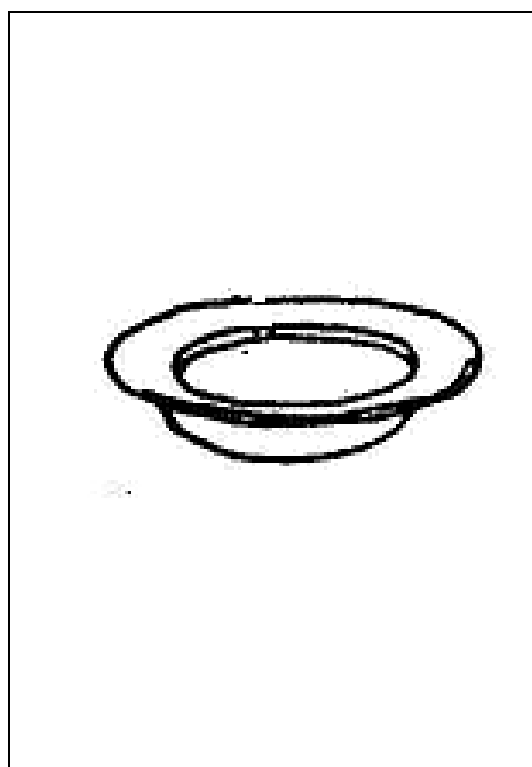
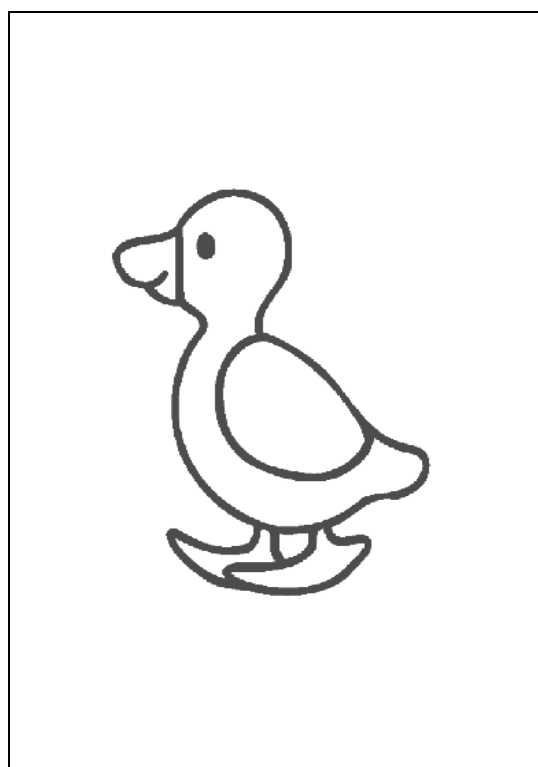

70

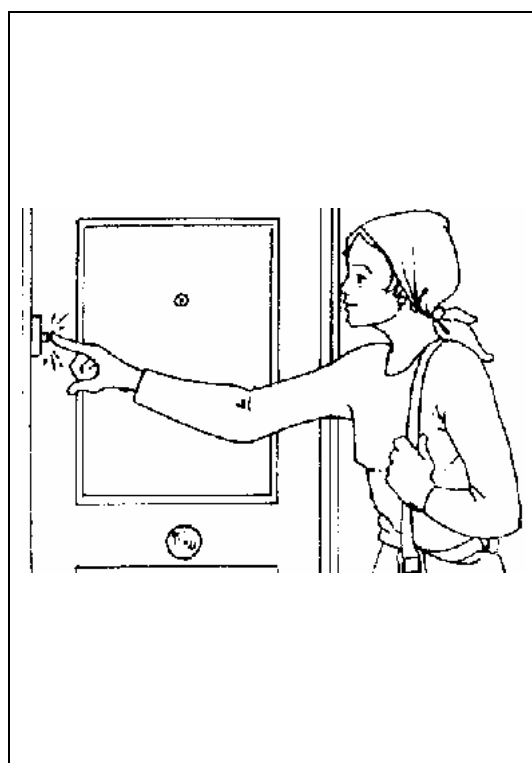
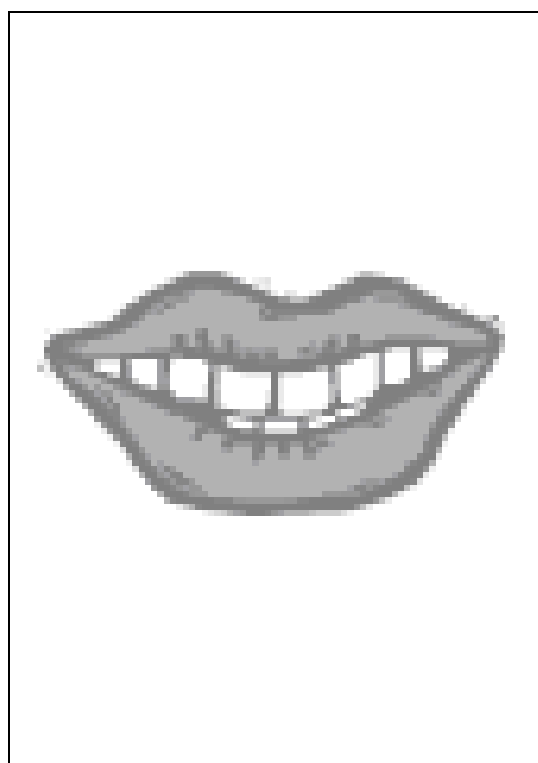

6

[Escribir texto]

Osorio- Nanjarí- Fonoaudiología

[Escribir texto]

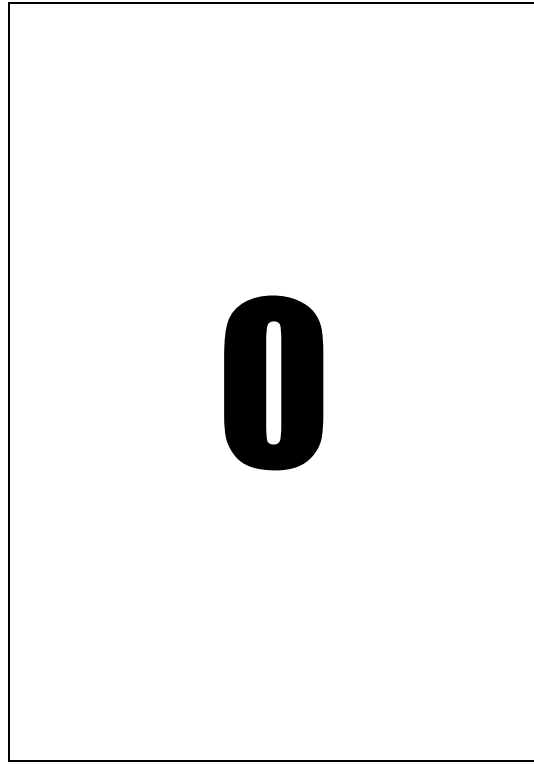
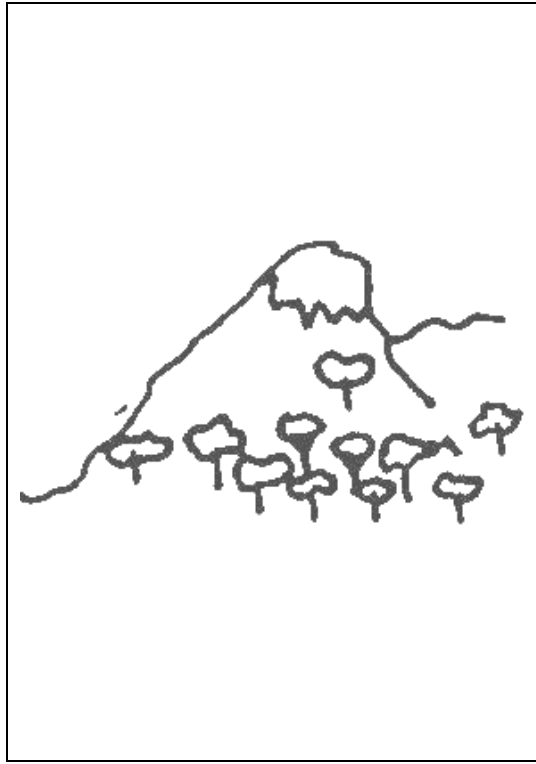

52

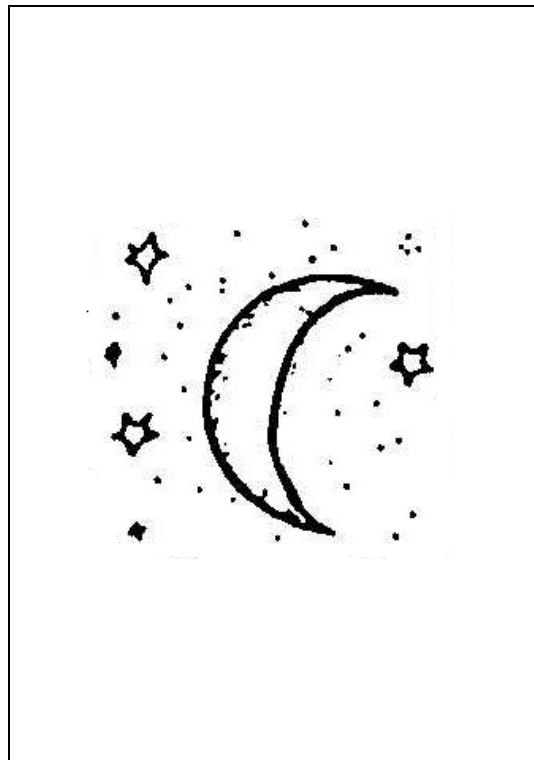
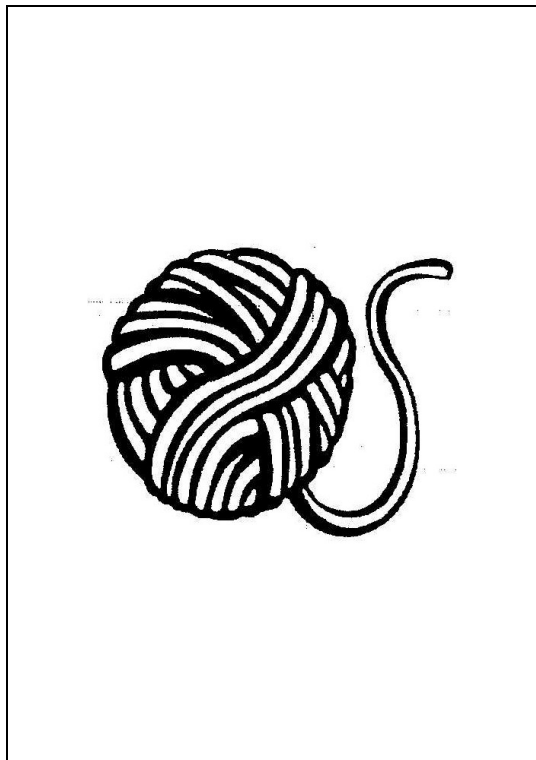

63

[Escribir texto]

Osorio- Nanjarí- Fonoaudiología

[Escribir texto]

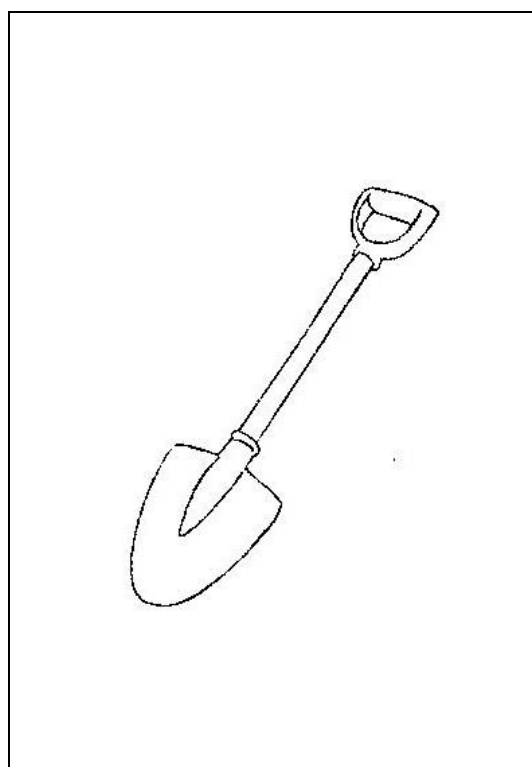
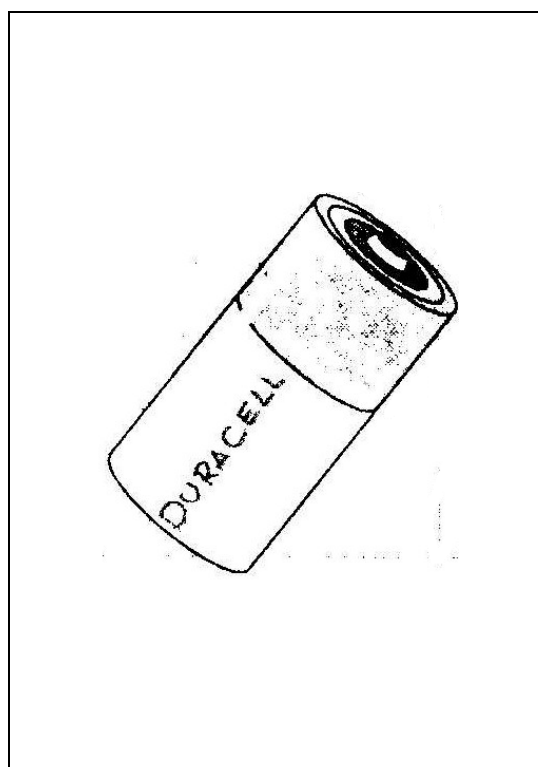

67

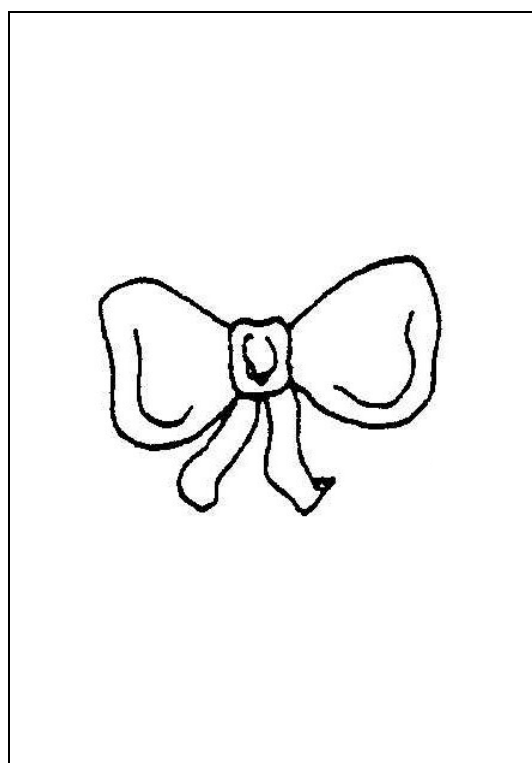
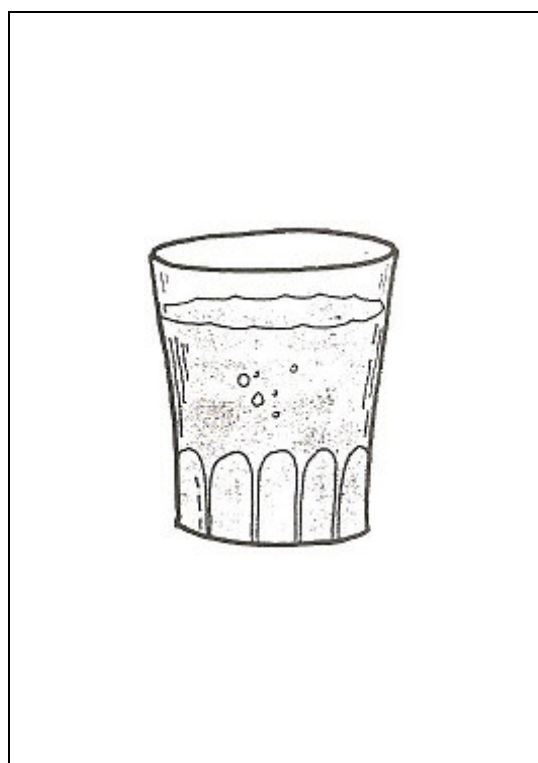

8

[Escribir texto]

Osorio- Nanjarí- Fonoaudiología

[Escribir texto]

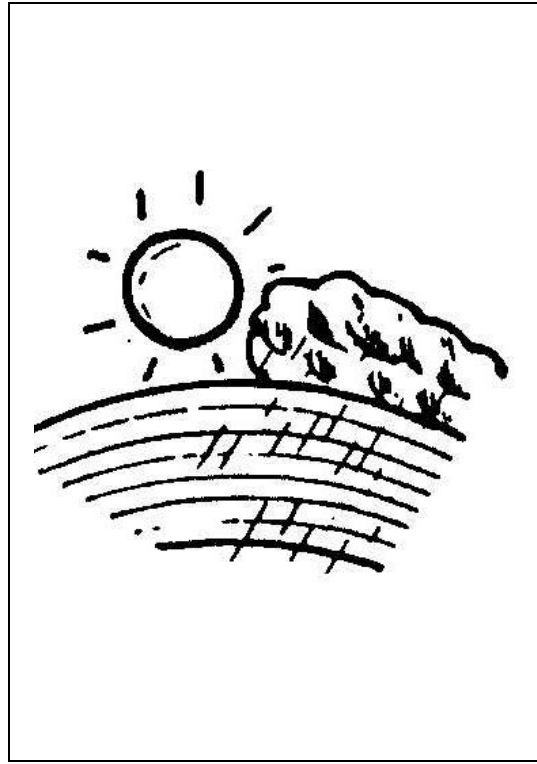
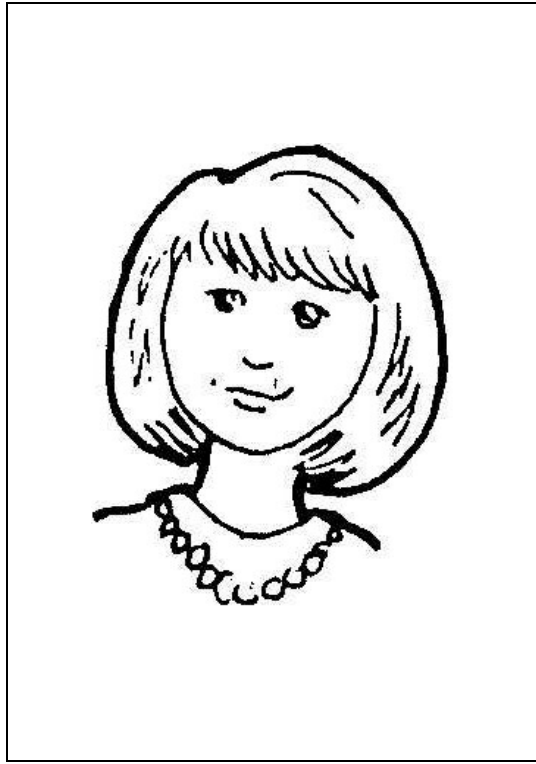

25

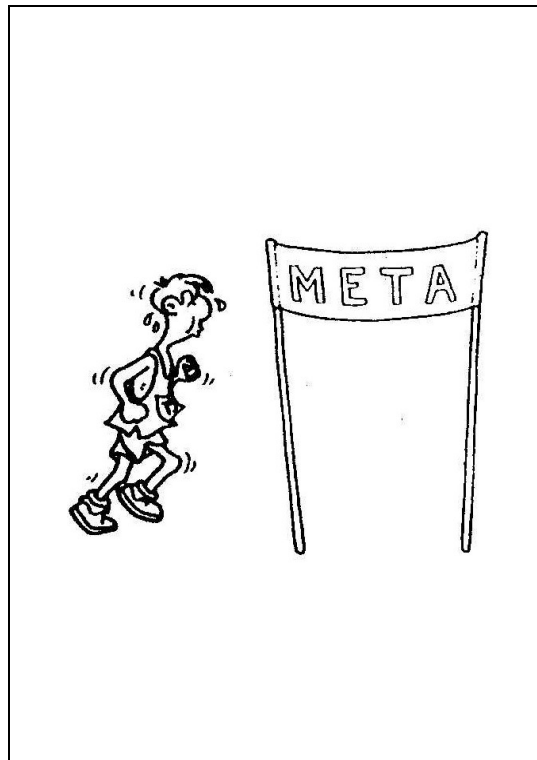
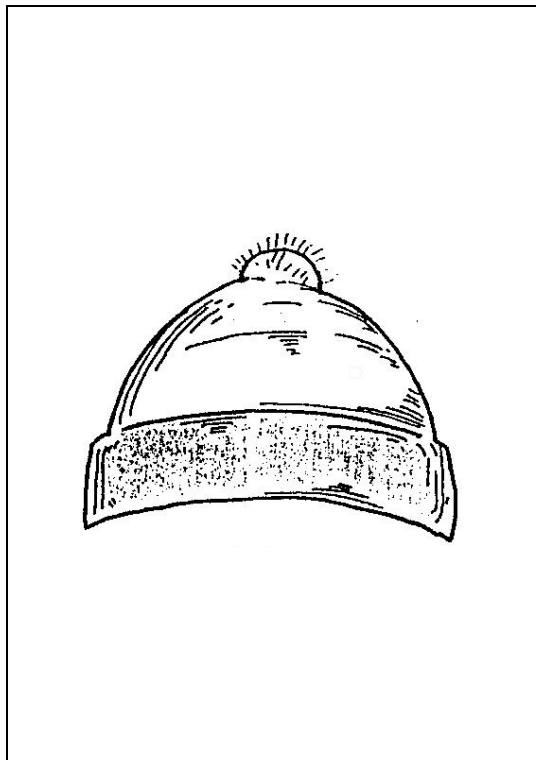

57

[Escribir texto]

Osorio- Nanjarí- Fonoaudiología

[Escribir texto]



[Escribir texto]

Osorio- Nanjarí- Fonoaudiología

[Escribir texto]